



ALUMINIUM GREENHOUSE

Riga S / Riga

Subject to technical changes!

Version 1.2022

Basic kit assembly instructions



model Riga S

Width 2,32 m / 7ft 8in



www.exaco.com

877-760-8500

customerservice@exaco.com

Assembly Animation Video
is available on our YouTube page, find
the link at www.exaco.com or
scan the QR code below:



model Riga

Width 2,96 m / 9ft 8in



Table of Contents

Before You Begin.....	2-3
Polycarbonate Information.....	4
Foundation Frame (optional accessory).....	5-6
Site Planning and Preparation with Foundation Measurements.....	7
Main Box Contents – Basic Kit.....	8-9
Gable Assembly.....	10-11
Roof Windows	
Roof Window Parts/Assembly.....	12-14
Roof Window Auto Opener.....	15-16
Wind Restraints for High Wind (optional).....	17
Door Assembly	
Door Bottom Half.....	18-19
Door Top Half	20-21
Door Catch Installation.....	22
Rear Window.....	23-24
Putting It All Together	
Assembling the Eaves/Sidewalls.....	25-27
Installing roof windows/doors	27
Polycarbonate Size/Count Sheet.....	28
Optional Accessories (may not be included with your kit)	
Riga Top Shelf.....	29-31
Riga Bottom Table Shelf.....	32-35
Exhaust Fan Installation.....	36
Intake Vent Installation.....	37
Riga Metal Hook Assembly.....	38
Assembly Help Contact Information.....	front and back covers

Thank you for purchasing a Riga greenhouse!

Please read all the assembly instructions then follow them step by step. We also recommend following our YouTube animated assembly video. Find the link to the Exaco YouTube page on our website at www.exaco.com. If you have questions or run into any difficulty, please give us a call at 877-760-8500.

What to do First:

The driver will have a Bill of Lading which will have the quantity of boxes you should receive. Check all the outer boxes for damage and make sure you have the correct quantity. If you are missing a box or see damage - write this on the Bill of Lading before the driver leaves. Notify Exaco as soon as possible if any of the boxes are damaged or missing.

In the case of damage:

Please do not refuse any of the boxes or the whole shipment, because of any damage. We will gladly replace any damaged items. Sending replacement parts is a simple and easy process. Contact Exaco Customer Service at 877-760-8500 or email us at customerservice@exaco.com. Photos will help us identify the parts and see the extent of damage.

Storage:

Please keep all the boxes in a dry place and protect against sunlight (see not regarding polycarbonate below). If stored outdoors, protect securely with tarps.

Placement of greenhouse:

If possible, choose a sunny location, avoiding the shadows of buildings and trees. For vegetables, it is recommended to position your greenhouse in a north-south orientation if possible - for flowers and potted plants, east-west.

Protection from heavy winds:

If your area is subject to very strong wind gusts, we strongly recommend adding some additional wind protection such as: a row of small trees, large shrubs or a wooden fence. Please contact Exaco Trading customer service to discuss additional anchoring options and window bracing kits for high wind.

Warning:

To prevent injury or damage, do not attempt assembly of this greenhouse in windy conditions. It is dangerous to leave a greenhouse partially assembled. Damages during assembly process, due to bad weather, are not covered by our warranty.

Assembly:

Much of the assembly can be done by one person, but it is most helpful to have a second pair of hands available. Assembling the windows, doors and gables ahead of time will make you familiar with the process and will make the main assembly go quicker and more smoothly.

Special Note:

Much of the greenhouse is assembled with series of bolts that are inserted into the channels on the aluminum profiles/extrusions. If you miss inserted a bolt where needed, there are insertion points in the black ends of the vertical and curved profiles/extrusions. You may also create your own insertion point with a 1/2" drill bit. This will not compromise the integrity of the structure.

For assembly, you will need the following tools:

- 1 pc. Phillips screwdriver size 2
- 1 pc. 10mm Wrench
- 1 pc. 3mm allen key (included in the accessoires bag of the roof window)
- 1 pc. level
- 1 pc. stepladder
- 1 pc. file to remove any burrs on the profile
- 1 pc. rubber mallet
- 1 pc. tape measure - combination metric/inches is best

!!!Note: Important information for glazing!!!

When installing the polycarbonate glazing make sure the UV coated side faces out. Loosen the edges of the protective film for installation. After the assembly is complete pull it off immediately. Do not leave the film on for any period of time in the sunlight. Several days of sunlight can burn the film firmly on the glazing. Markings on the film will indicate the UV coating. In most cases, the factory is sending polycarbonate that is UV coated on BOTH sides - this should be indicated with markings on the protective film. If you are unsure, please give us a call.

Do not pull the film off right out of the box, otherwise you cannot tell which side has the UV protection! Suggestion: If you plan on disassembling and moving you should mark the UV side of each panel before installation. A small circle in a lower corner with a permanent marker will work well.

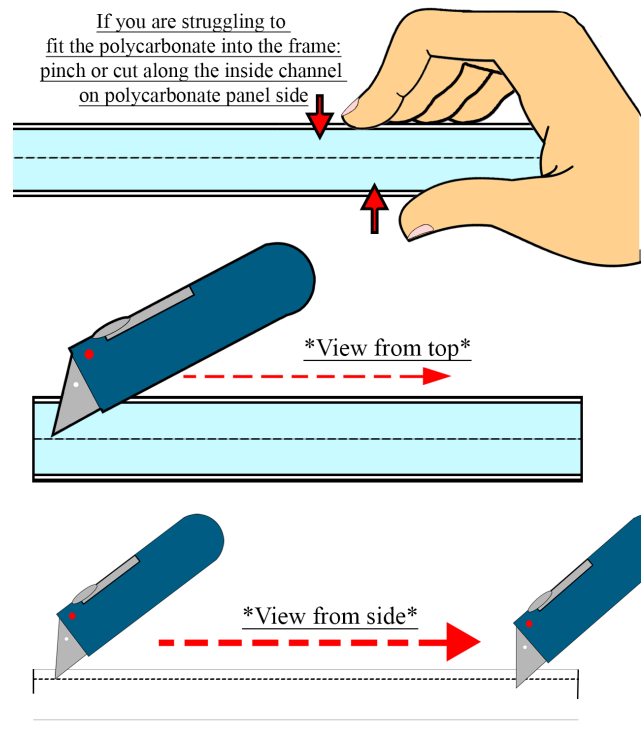

Question: Does the greenhouse glazing need to be completely sealed?

We recommend that you seal the horizontal transitions where the glazing meets the aluminum profiles with a neutral cure transparent silicone. (Shown in the diagram below by dashed lines.) This will prevent water and dirt from entering the glazing slots.

Advantage: The greenhouse stays looking new as the seal prevents the formation of algae and buildup of dirt/dust inside the glazing.

During some weather conditions condensation can occur within the hollow chambers of the glazing. This is because the glazing chambers are not air tight. The condensation is purely aesthetic and cannot be avoided. The condensation/water vapor will not damage the glazing, even at freezing temperatures.

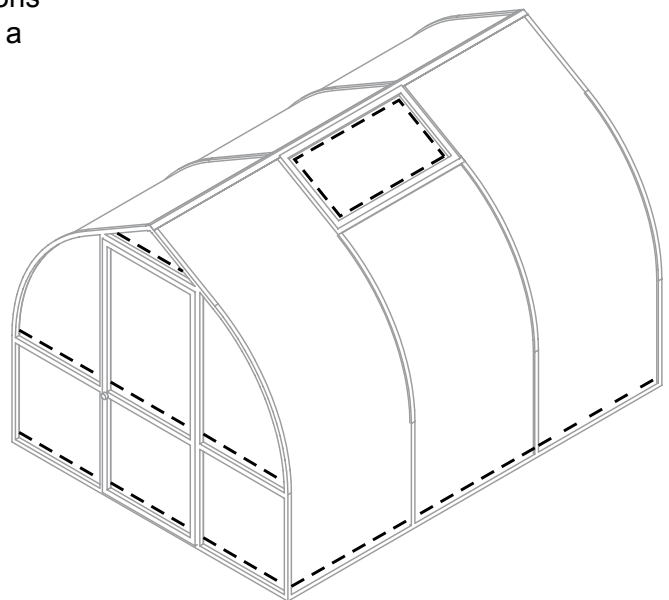

Warning: Use only neutral cure silicone, otherwise it may lead to stress cracks in glazing. Neutral cure silicone is available in most hardware stores. We recommend Boss brand 400 Colors in #157 Clear. You can purchased Boss directly from us, just call 1-877-760-8500.

Cleaning and care: To wash the greenhouse use plenty of water, a soft car wash brush and a little mild dish soap - Palmolive works well.

Foundation frame (optional accessory)

ATTENTION: The Foundation Frame/Soil profile are assembled to check for level and square. This is not final and will need to be disassembled. Do not permanently attach corners or fill in the gable end trenches with dirt. The side wall trenches can be partially filled with dirt. Once this step has been completed go to Step 1 on page 10.

The optional Riga foundation frame is the easiest and the safest foundation for a greenhouse. It requires no concrete.

ATTENTION: When using the Riga foundation frame attach it to the soil profile before these steps (see pages 5, 6)

The foundation frame hooks into the soil profile and the corners are bolted together with a corner angle (V26). (See page 6). Use the supplied self tapping screws to firmly attach the soil profile to the foundation frame.

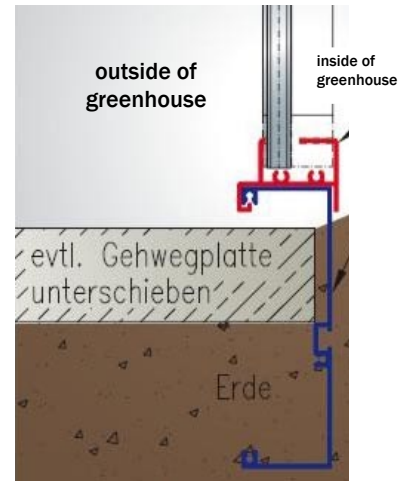

Setting up the foundation frame

Dig a small ditch 4-5 inches deep in the dimensions of the foundation frame.

Use paving stones or gravel under the horizontal sections as much as possible to prevent the potential for the greenhouse to sag.

It is also very practical to install tile or stone flooring, this prevents the mud from splashing on the greenhouse during heavy rain and makes work easier around the greenhouse, such as mowing the lawn.

Profiles and accessories for foundation frame *Riga S*: # - See next page!

overview	pos.	description	number/length in mm/inches		
			type II	type III	type IV
	6.1	foundation frame profile gable #	2 2199 mm 86 9/16"	2 2199 mm 86 9/16"	2 2199 mm 86 9/16"
	6.2	foundation frame profile eaves #	2 2033 mm 80 1/16"	2 3091 mm 121 11/16"	2 4149 mm 163 3/8"
	V26	foundation frame corner bracket 40/40/2 x 105 item no 9999 0078	4 105 mm 4 1/8"	4 105 mm 4 1/8"	4 105 mm 4 1/8"
	V27	mounting bracket (rung/foundation frame) item no 9999 0267	10 135 mm 5 5/16"	10 135 mm 5 5/16"	10 135 mm 5 5/16"
	S12 S1	hexagonal screw M6 x 12 + nut M6 item no 9999 0124 + 9999 0128	20	20	20

Profiles and accessories for foundation frame *Riga*: (V26/V27/S12/S1 as above)

overview	pos.	description	number/length in mm/in		
			type III	type IV	type V
	6.1	foundation frame profile gable	2 2835 mm 111 5/8"	2 2835 mm 111 5/8"	2 2835 mm 111 5/8"
	6.2	foundation frame profile eaves	2 3091 mm 121 11/16"	2 4149 mm 163 3/8"	2 5207 mm 205"

Assembly foundation frame

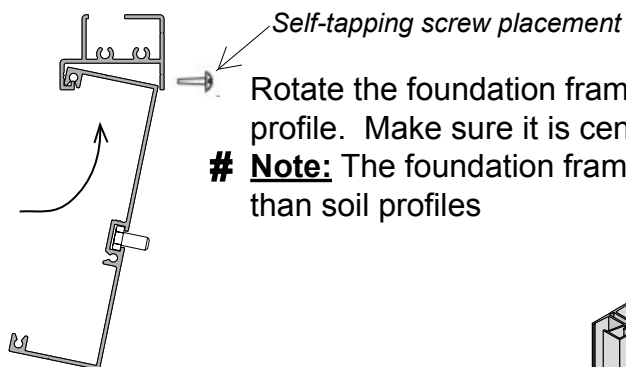

In the foundation frame corners use two M6 x 12 bolts (S12) and one corner bracket (V26) Fasten them with two M6 nuts (S1).

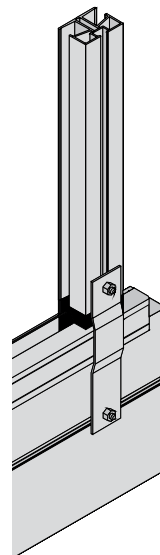

Attaching the greenhouse to your own foundation or anchoring system

We recommend that you use anchor bolts to secure the soil profile to your foundation. The anchor bolts are **not** included.

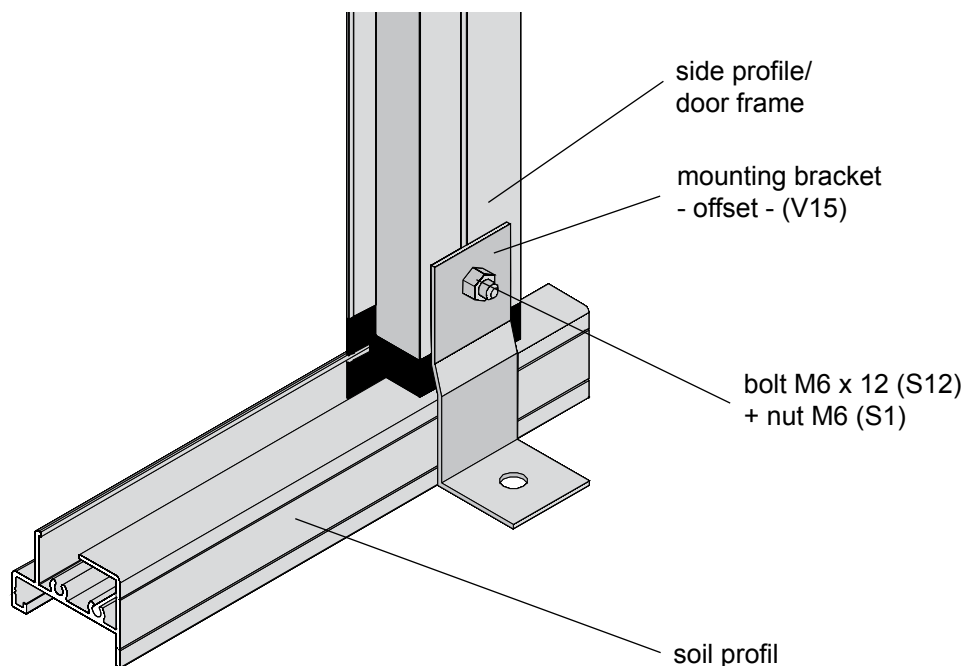

Greenhouse on a Stem Wall

(Requires optional door extension/drop door kit)

You must have a door extension kit to place the Riga greenhouse on a stem/knee wall. The wall must be 20" high and the rough opening for the front door should be 33" wide.

Use the greenhouse exterior dimensions for your wall exterior dimensions - this will ensure your doors will open fully and connect with your door catch. Please be sure the thickness of your wall allows for secure anchoring and meets local building standards.

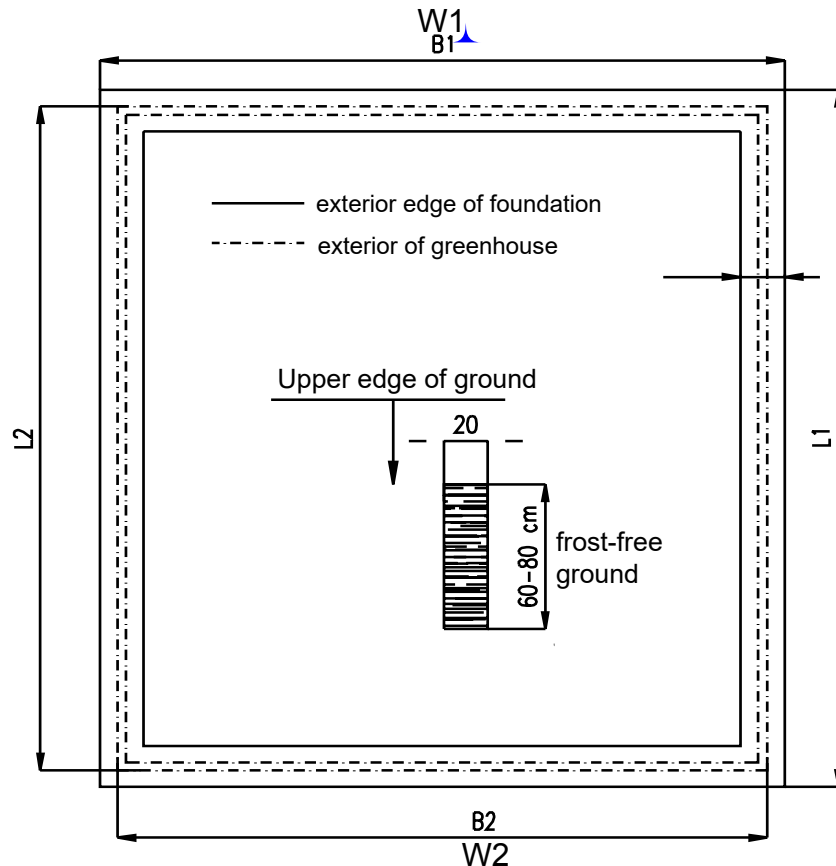

Foundation plan Riga S/Riga

Construction with a perimeter or strip foundation

If you have not purchased a foundation frame secure the greenhouse by means of a strip or perimeter foundation. Create the foundation in accordance with the specified dimensions below.

A stone/cement base is not required. The greenhouse can be placed directly on the ground but it must be anchored securely.

You may also place the greenhouse on a full slab foundation - consider texture and drainage.

Please make sure that the foundation is level in all directions.

Once assembled, anchor the greenhouse with the included mounting brackets (V15)

Screws and anchors are **not** included.

Suggestion: Assemble the lower frame (soil profiles 1.1/2.1, soil profile corner V9) of the greenhouse to use as a template to create a stone or concrete foundation. Make sure the corners are square. This will prevent any errors in measurement.

model	foundation		greenhouse	
	W1	L1	W2	L2
Riga S II	249cm / 98 1/16"	232cm / 91 5/16"	233cm / 91 3/4"	216cm / 85 1/16"
Riga S III	249cm / 98 1/16"	338cm / 133 1/16"	233cm / 91 3/4"	322cm / 126 3/4"
Riga S IV	249cm / 98 1/16"	443cm / 174 7/16"	233cm / 91 3/4"	427cm / 168 1/8"
Riga III	312cm / 122 13/16"	338cm / 133 1/16"	296cm / 116 9/16"	322cm / 126 3/4"
Riga IV	312cm / 122 13/16"	443cm / 174 7/16"	296cm / 116 9/16"	427cm / 168 1/8"
Riga V	312cm / 122 13/16"	549cm / 216 1/8"	296cm / 116 9/16"	533cm / 209 13/16"



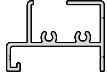
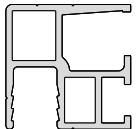
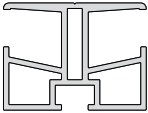

Main box Contents - basic kit Riga S/Riga

Please check contents list to make sure all items are there

Profiles for both gables:

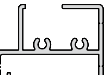
overview	pos.	description	number/length in in					
			Riga S			Riga		
			II	III	IV	III	IV	V
	1.1	soil profile/gable	2 $\frac{2238 \text{ mm}}{88 \frac{1}{8} \text{ ''}}$	2 $\frac{2238 \text{ mm}}{88 \frac{1}{8} \text{ ''}}$	2 $\frac{2238 \text{ mm}}{88 \frac{1}{8} \text{ ''}}$	2 $\frac{2874 \text{ mm}}{113 \frac{1}{8} \text{ ''}}$	2 $\frac{2874 \text{ mm}}{113 \frac{1}{8} \text{ ''}}$	2 $\frac{2874 \text{ mm}}{113 \frac{1}{8} \text{ ''}}$
	1.5.4	Edge curve left	2	2	2	2	2	2
	1.5.6	Edge curve right	2	2	2	2	2	2
	1.6	door frame left with slant	2 $\frac{1876 \text{ mm}}{73 \frac{7}{8} \text{ ''}}$	2 $\frac{1876 \text{ mm}}{73 \frac{7}{8} \text{ ''}}$	2 $\frac{1876 \text{ mm}}{73 \frac{7}{8} \text{ ''}}$	2 $\frac{2059 \text{ mm}}{81 \frac{1}{16} \text{ ''}}$	2 $\frac{2059 \text{ mm}}{81 \frac{1}{16} \text{ ''}}$	2 $\frac{2059 \text{ mm}}{81 \frac{1}{16} \text{ ''}}$
	1.7	door frame right with slant and holes	2 $\frac{1876 \text{ mm}}{73 \frac{7}{8} \text{ ''}}$	2 $\frac{1876 \text{ mm}}{73 \frac{7}{8} \text{ ''}}$	2 $\frac{1876 \text{ mm}}{73 \frac{7}{8} \text{ ''}}$	2 $\frac{2059 \text{ mm}}{81 \frac{1}{16} \text{ ''}}$	2 $\frac{2059 \text{ mm}}{81 \frac{1}{16} \text{ ''}}$	2 $\frac{2059 \text{ mm}}{81 \frac{1}{16} \text{ ''}}$
	1.8	door frame top	2 $\frac{758 \text{ mm}}{29 \frac{13}{16} \text{ ''}}$	2 $\frac{758 \text{ mm}}{29 \frac{13}{16} \text{ ''}}$	2 $\frac{758 \text{ mm}}{29 \frac{13}{16} \text{ ''}}$	2 $\frac{758 \text{ mm}}{29 \frac{13}{16} \text{ ''}}$	2 $\frac{758 \text{ mm}}{29 \frac{13}{16} \text{ ''}}$	2 $\frac{758 \text{ mm}}{29 \frac{13}{16} \text{ ''}}$
	1.8	cross bar in the side door without	1 $\frac{758 \text{ mm}}{29 \frac{13}{16} \text{ ''}}$	1 $\frac{758 \text{ mm}}{29 \frac{13}{16} \text{ ''}}$	1 $\frac{758 \text{ mm}}{29 \frac{13}{16} \text{ ''}}$	1 $\frac{758 \text{ mm}}{29 \frac{13}{16} \text{ ''}}$	1 $\frac{758 \text{ mm}}{29 \frac{13}{16} \text{ ''}}$	1 $\frac{758 \text{ mm}}{29 \frac{13}{16} \text{ ''}}$
	1.9	cross bar left and right	4 $\frac{702 \text{ mm}}{27 \frac{5}{8} \text{ ''}}$	4 $\frac{702 \text{ mm}}{27 \frac{5}{8} \text{ ''}}$	4 $\frac{702 \text{ mm}}{27 \frac{5}{8} \text{ ''}}$	4 $\frac{1020 \text{ mm}}{40 \frac{3}{16} \text{ ''}}$	4 $\frac{1020 \text{ mm}}{40 \frac{3}{16} \text{ ''}}$	4 $\frac{1020 \text{ mm}}{40 \frac{3}{16} \text{ ''}}$

Profiles for eaves:

overview	pos.	description	number/length in mm					
			Riga S			Riga		
			II	III	IV	III	IV	V
	2.1	soil profile/eave	2 $\frac{2072 \text{ mm}}{81 \frac{9}{16} \text{ ''}}$	2 $\frac{3130 \text{ mm}}{123 \frac{1}{4} \text{ ''}}$	2 $\frac{4188 \text{ mm}}{164 \frac{14}{16} \text{ ''}}$	2 $\frac{3130 \text{ mm}}{123 \frac{1}{4} \text{ ''}}$	2 $\frac{4188 \text{ mm}}{164 \frac{14}{16} \text{ ''}}$	2 $\frac{5246 \text{ mm}}{206 \frac{9}{16} \text{ ''}}$
	2.3	Side curve	2	4	6	4	6	8
	3.2	cross bar/roof window	1 $\frac{1020 \text{ mm}}{40 \frac{3}{16} \text{ ''}}$	1 $\frac{1020 \text{ mm}}{40 \frac{3}{16} \text{ ''}}$	2 $\frac{1020 \text{ mm}}{40 \frac{3}{16} \text{ ''}}$	1 $\frac{1020 \text{ mm}}{40 \frac{3}{16} \text{ ''}}$	2 $\frac{1020 \text{ mm}}{40 \frac{3}{16} \text{ ''}}$	4 $\frac{1020 \text{ mm}}{40 \frac{3}{16} \text{ ''}}$
	3.3	ridge profile	1 $\frac{2137 \text{ mm}}{84 \frac{1}{8} \text{ ''}}$	1 $\frac{3195 \text{ mm}}{125 \frac{13}{16} \text{ ''}}$	1 $\frac{4253 \text{ mm}}{167 \frac{7}{16} \text{ ''}}$	1 $\frac{3195 \text{ mm}}{125 \frac{13}{16} \text{ ''}}$	1 $\frac{4253 \text{ mm}}{167 \frac{7}{16} \text{ ''}}$	1 $\frac{5311 \text{ mm}}{209 \frac{1}{8} \text{ ''}}$
	3.4	angle stabilization	4 $\frac{2014 \text{ mm}}{82 \frac{13}{16} \text{ ''}}$	4 $\frac{3162 \text{ mm}}{124 \frac{1}{2} \text{ ''}}$	4 $\frac{4220 \text{ mm}}{166 \frac{1}{8} \text{ ''}}$	4 $\frac{3162 \text{ mm}}{124 \frac{1}{2} \text{ ''}}$	4 $\frac{4220 \text{ mm}}{166 \frac{1}{8} \text{ ''}}$	4 $\frac{5278 \text{ mm}}{207 \frac{13}{16} \text{ ''}}$

Accessories bag basic kit Riga S/Riga

overview	pos.	description/ item number		num- ber RigaS	num- ber Riga
	V9	Soil profile corner item no 9999 0003		4	4
	V5	connecting plate item no 9999 0028	Edge Clamp/Door Frame	4	4
	V10	connecting plate 90 x 35 mm item no 9999 0030	For mounting cross bar/rear	2	2
	V11	endplate ridge/gutter item no 9999 0075		2	2
	V4	connecting plate item no 9999 0031	for cross bar/roof window	II = 2 III = 2 IV = 4	III = 2 IV = 4 V = 8
	V12	corner 30/30/2/15 mm item no 9999 0072	soil profile screw the corner from inside	4	4
	S21	blind plug Ø10 mm item no 9999 0097	To plug Edge profile hole to attach cross bar	4	4
	V14	door hose section 760 mm lg. item no 9999 0181	door threshold seal	1	1
	V23	wedge seal 3 - 5 mm item no 9999 0119	sealing the soil profile insid	See table page 4	See table page 4
	S9	screw pan head 4,2x13 item no 9999 0144	door frame-soil profile cover plate/corner (V12)	38*	38*
	S13	screw, pan head 4,8 x 45 item no 9999 0150	gable	6	6
	S5/ S1	hexagonal screw M6 x 16 + nut item no 9999 0183 + 9999 0128	bolts for construction of greenhouse	II = 40* III = 40* IV = 44*	III = 40* IV = 44* V = 48*
	V15	mounting bracket - offset 74 x 30 x 33 mm item no 9999 0207	for the attachment of the greenhouse to a foundation made by customer (not with foundation frame)	10	10
	S32	washer A6,4 item no 9999 0173	door frames, roof and side profiles	20	20 V = 24
	V1	mounting corner bracket inside item no 9999 00074		2x left 2x right	2x left. 2x right

Assembly procedure gable

view from inside

ATTENTION! When using a foundation frame attach it to soil profile in advance (see pages 5, 6)

step 1

soil profile corner (V9)

door frame left (pos. 1.6)

door frame right (pos. 1.7)

soil profile (pos. 1.1)

to step 1:

Items needed:
 Pos 1.6 (Door frame left)
 Pos 1.7 (Door frame right with 8 holes)
 Pos 1.1 (Soil Profile)
 Soil Profile Corner (V9)
 Slide pos 1.6 and pos 1.7 up to the small holes in the middle of pos 1.1 (soil profile). The chamfered edge must be facing to the outside. Then attach the soil profile corner (V9) to the ends of the soil profile.

step 2

Riga S	Riga
730 x 728	1048 x 728

glazing

glazing

Attach with screw pan head 4,2 x 13 (S9)
after the door is mounted and aligned

to step 2:

Now you need the small side glazing. Slide the side glazing into the door frames and soil profile. The dimensions are listed in the diagram.

Note: After the door is mounted and aligned attach pos 1.6 and pos 1.7 with pan head screw 4,2 x 13 (S9).

step 3

cross bar (pos. 1.9)

cross bar (pos. 1.9)

to step 3:

Now insert the cross bar (pos. 1.9) onto the top of the glazing.

step 4

view from inside

screw pan head 4,2 x 13 (S9)

connecting plate (V5)

door frame top (pos. 1.8)

glazing

glazing

screw M6 x 16 (S5) with nut M6 (S1)

to step 4:

Items needed:
 Two Connecting Plates (V5)
 Pos 1.8 (Cross Bar-door frame top)
 Four Hex Screws M6 x 16 (S5)
 Slide one hex screw M6 x 16 (S5) into the vertical door frames (pos 1.6/1.7) and two in the crossbar (pos 1.8)
 Attach the crossbar to the door frames with the connecting plate (V5).
 Insert the curved glazing into the door frames and cross bar (pos 1.9)

Assembly procedure gable

ATTENTION! When using a foundation frame attach it to soil profile in advance (see pages 5, 6)

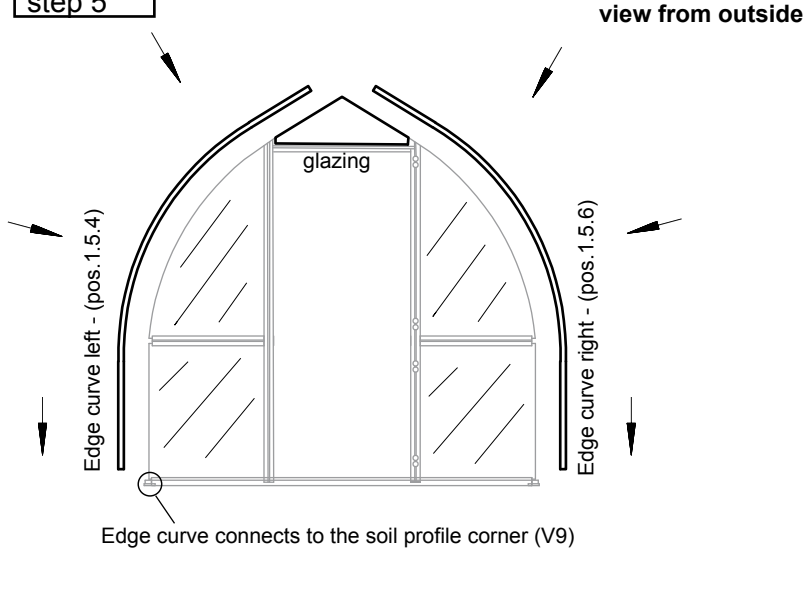
<p>step 5</p> <p>view from outside</p> 	<p>to step 5:</p> <p>The square peg in the soil profile corner (V9) is plugged into the bottom of the Edge curve (pos.1.5.4/1.5.6).</p> <p>The small triangular glazing is positioned in the door frame top (pos 1.8)</p> <p>The Edge curve (pos.1.5.4/1.5.6) is attached to the door frame using the connecting plate (V5), installed in step 4, and 2 screws pan head 4,2 x 13 (S9). Insert 2 bolts into the channel of each edge curve for attaching lateral support later.</p> <p>All fasteners should be hand tight.</p> <p>- See also step 4! -</p>
---	--

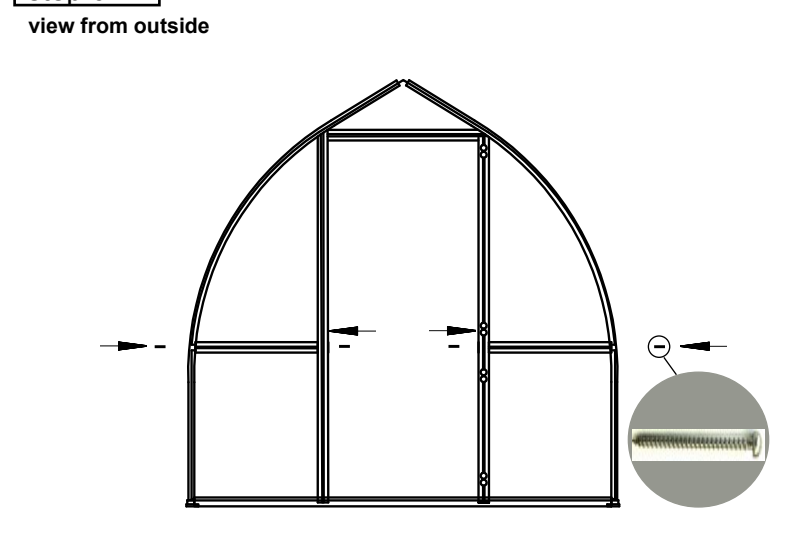
<p>step 6:</p> <p>view from outside</p> 	<p>to step 6:</p> <p>The cross bars (pos.1.9) are mounted horizontally with the pan head screw 4,8 x 45 (S13).</p>
---	---

The rear gable is assembled in the same way!!!

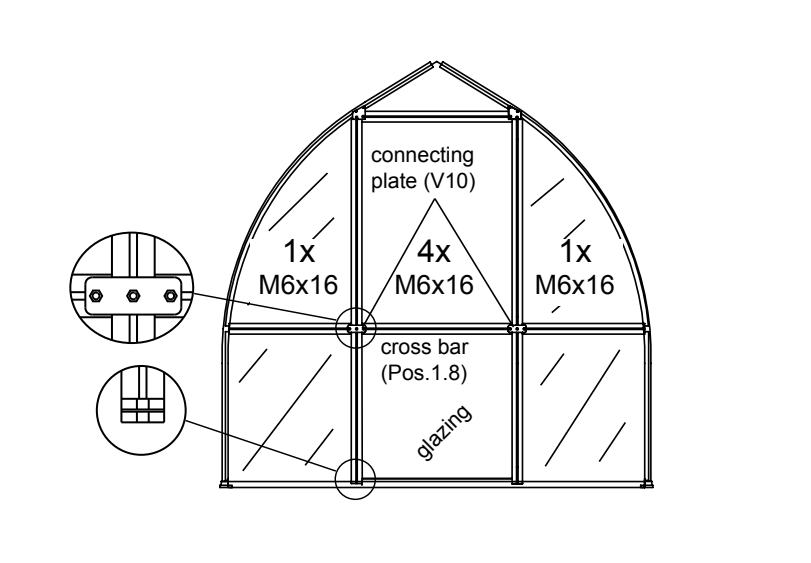

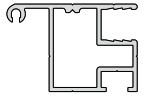

<p>step 7:</p> <p>Only rear gable!</p> 	<p>to step 7:</p> <p>Slide the upright profiles (pos 1.6/1.7) into the soil profile.</p> <p>Insert the (787 x 728 mm) glazing between the upright profiles (pos 1.6/1.7)</p> <p>Insert one M6 x 16 (S5) into each upright profile (pos 1.6/1.7)</p> <p>Insert four M6 x 16 (S5) into the cross bar (pos 1.8)</p> <p>Insert one M6 x 16 (S5) into each cross bar (pos 1.9)</p> <p>Connect the upright profiles (pos 1.6/1.7) to the cross bars (1.8/1.9) with connecting plates (V10)</p> <p>Attach the edge curve left/right (pos.1.5.4/1.5.6) to the cross bars (1.9) with the pan head screw 4,8 x 45 (S13). Insert 2 bolts into the channel of each edge curve for attaching lateral support later.</p>
--	--

Roof Windows



Profiles for roof windows (per roof window)

overview	pos.	description	number	length in mm
	4.1	roof window side profile	2	541 _{mm} / 21 _{3/16} "
	4.2	roof window top/bottom profil	2	953 _{mm} / 37 _{1/2} "

Content accessories bag roof window (per roof window)

overview	pos.	description/item number	number	length in mm
	V25	T-seal <small>item no 9999 0032</small>	2	641 _{mm} / 25 _{1/4} "
			1	1052 _{mm} / 41 _{7/16} "
	V13	corner with grub screw, internal hex and flat point <small>item no 9999 0070</small>	4	
	V21	allen key <small>item no 9999 0056</small>	1	
	S12/ S1	hexagonal screw M6 x 12 nut M6 <small>item no 9999 0124</small> <small>item no 9999 0128</small>	3	
	V24	corner bracket/roof window <small>item no 9999 0005</small>	4	

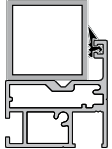
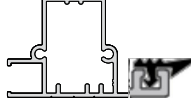
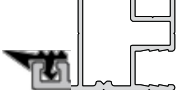
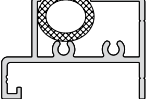
Gasket Notes:

	T-seal (V25) is for all doors and windows (total: 15 meters/49 feet) long flap goes towards exterior	 
	Attention! The T-seal (V25) is only inserted on three sides of the roof window. The top side slides into the roof beam so no seal is required.	
	In the door threshold, the hose section (V14) is pressed into the soil profile. This prevents dirt from getting into the soil profile.	
		 <p>Attention! In the lower door press the seal into the profile first then install the rectangular tube.</p>

* **Note:** The seal is bundled in one strand for all doors and windows, please cut accordingly.

Assembly roof window

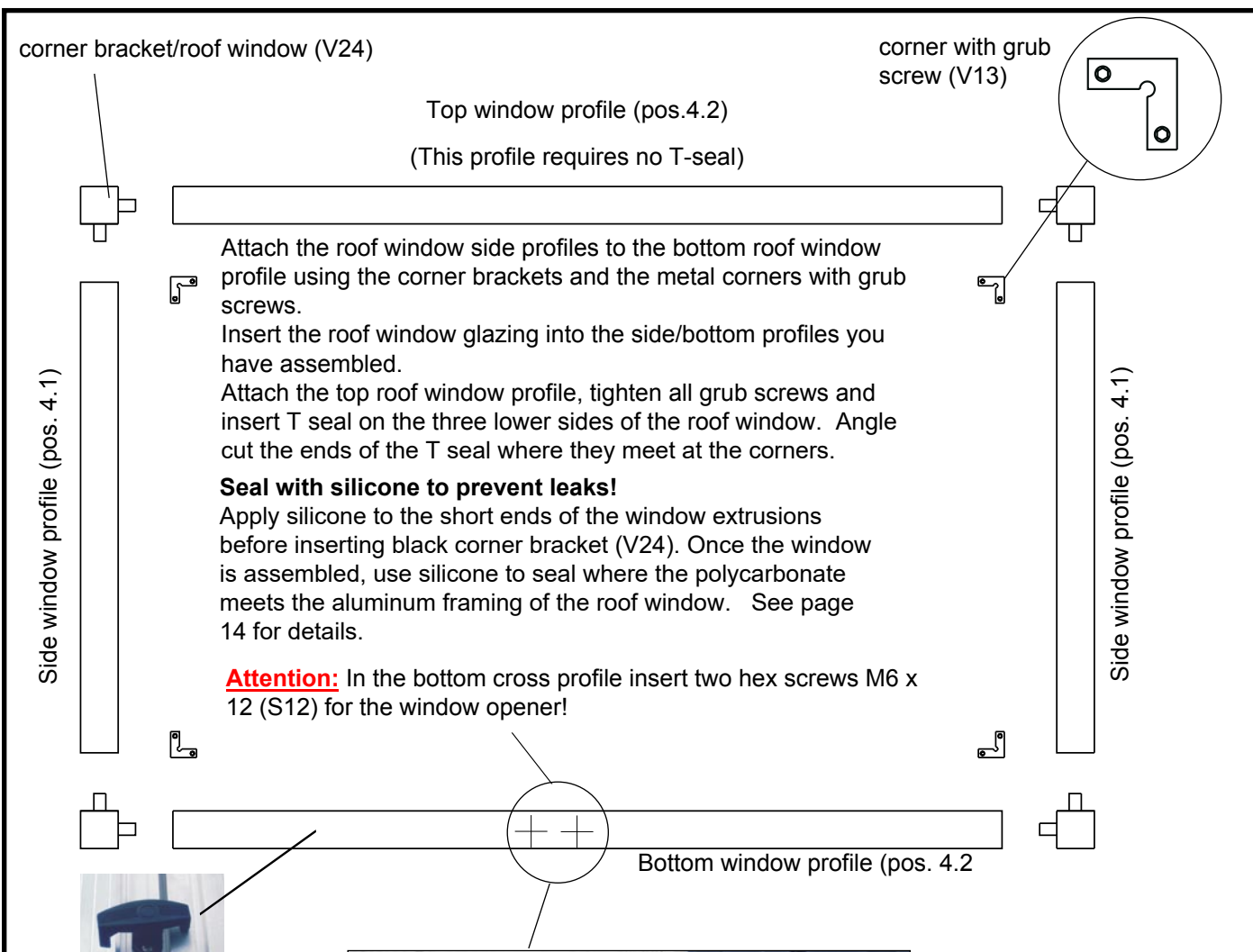

Attach the roof window side profiles to the bottom roof window profile using the corner brackets and the metal corners with grub screws.
 Insert the roof window glazing into the side/bottom profiles you have assembled.
 Attach the top roof window profile, tighten all grub screws and insert T seal on the three lower sides of the roof window. Angle cut the ends of the T seal where they meet at the corners.

Seal with silicone to prevent leaks!

Apply silicone to the short ends of the window extrusions before inserting black corner bracket (V24). Once the window is assembled, use silicone to seal where the polycarbonate meets the aluminum framing of the roof window. See page 14 for details.

Attention: In the bottom cross profile insert two hex screws M6 x 12 (S12) for the window opener!



sash lock (V28) may be attached here with screw countersunk head 3,5 x 22 (S19) screws.



automatic roof window opener

Mounting roof window

wrong!!!

right

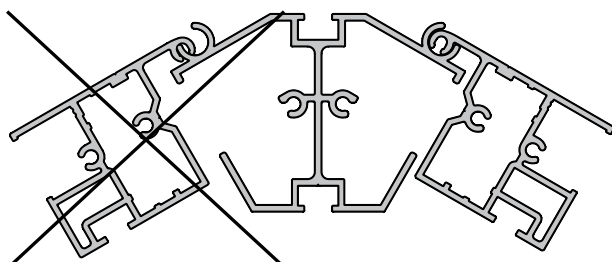

Please push the roof window from the gable end into the ridge profile and slide it into position.
 Install the automatic opener mount into the crossbar.

Sealing the roof window area

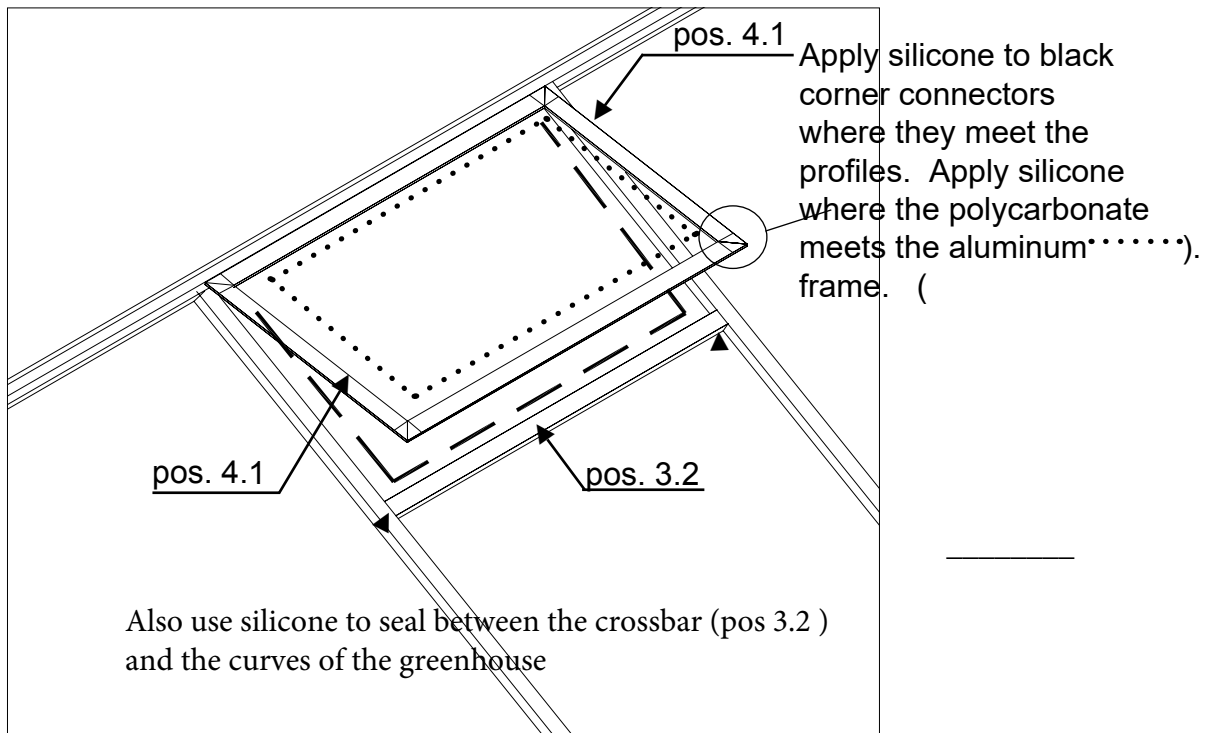

cross-section of the flat seal



length: 2,3 m

The flat seal is inserted as the sketch above.

Attention: Do not cut the flat seal in the corners! Run it in one continuous strip.

Please seal all connections of the roof window with silicone: Corner connector to side and bottom profile and glazing to side and bottom profiles. → see sketch.

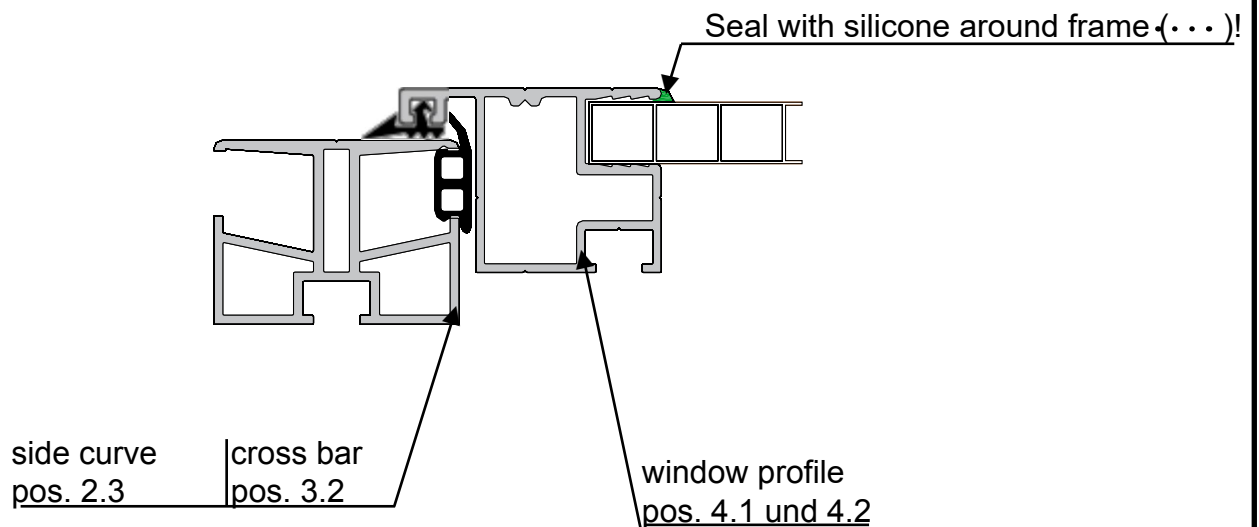

.....

Automatic Window Opener

1	opener frame
2	pressure cylinder
3	cotter pin
4	mounting plate window profile
5	mounting plate cross bar

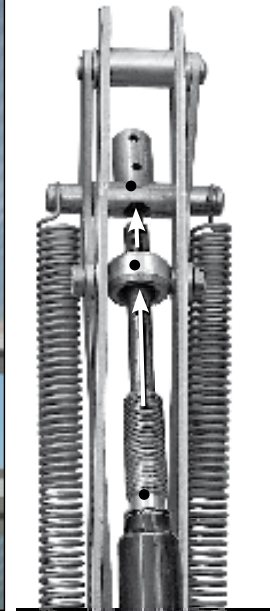
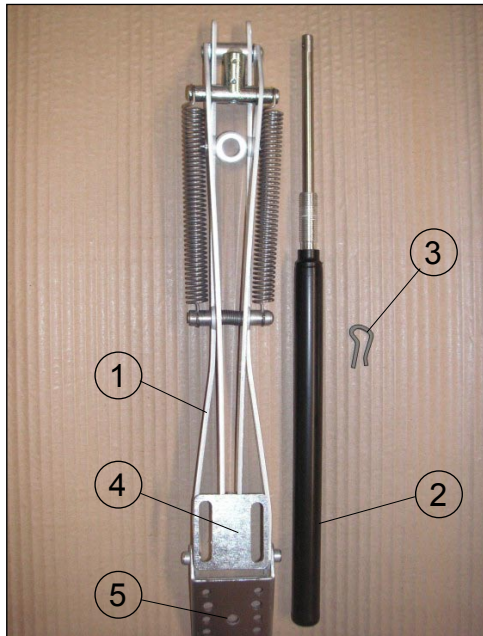
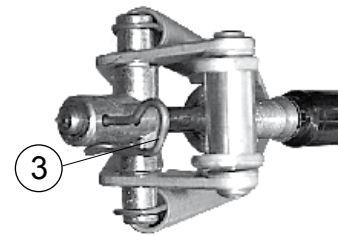

Auto Opener Installation

1. Check whether the greenhouse window can open and close freely and unhindered.
2. Install the opener with the mounting plate (4) in the center of the lower roof window profile (pos 4.2)
3. Secure the cylinder by lining up the hole in the piston with the upper hole in the T-coupling, then insert the cotter pin.
4. Install the mounting plate (5) in the center of the cross bar(pos 3.2) using the middle hole in the mounting plate(5)
5. Attach the opener frame (1) to the mounting plate (5). Open the roof window until the threads of the piston (2) engage the threads of the opener frame (1). Thread the piston (2) half way into the threads in the opener frame (1).

Adjustment:

Let the opener acclimate to the greenhouse for 3-4 hours before you make adjustments. For earlier engagement and a larger opening, turn the cylinder clockwise. For a delayed engagement and a smaller opening turn the cylinder counter clockwise. Make sure you don't back it out too far. For opening engagement advance/delay one full turn is about 1 degree Fahrenheit. Please keep in mind that greenhouse temperatures can vary and windows can have different opening tolerances.

Winter-usage:

When the temperature decreases and the window is no longer to be opened, or when a source of heat is used in the greenhouse:

1. Unscrew the cylinder from the cylinder housing. The cylinder is now hanging from the cotter pin and cannot open the window. The cylinder can be left hanging in this position over the winter.
2. Use a sash lock to lock the window shut for the winter so it cannot blow open.

Required Maintenance:

Every year, check to make sure the piston shaft and cylinder threads are greased and move freely. A dab of light oil such as WD40 or olive oil on the piston shaft and the cylinder threads will be sufficient. Failure to do so could render your opener inoperable.

Riga Greenhouse Window Auto Opener Correct Installation



In the correct position, the opener is sitting parallel to the window, which means that it will not demand a lot of pressure from the cylinder when the opening starts. Before fitting a new cylinder to the openers, you must check that the window can open freely right from the start. If not you must change the position of the aluminum profiles.



Roof Vent Recommendation for High Wind Areas

If you get strong wind gusts, we recommend protecting your roof vents and openers with restraint cables. Roof vent restraints can be purchased from Exaco Trading (US distributor of Rigas) or can be made, they are not a standard part from the Riga manufacturer.

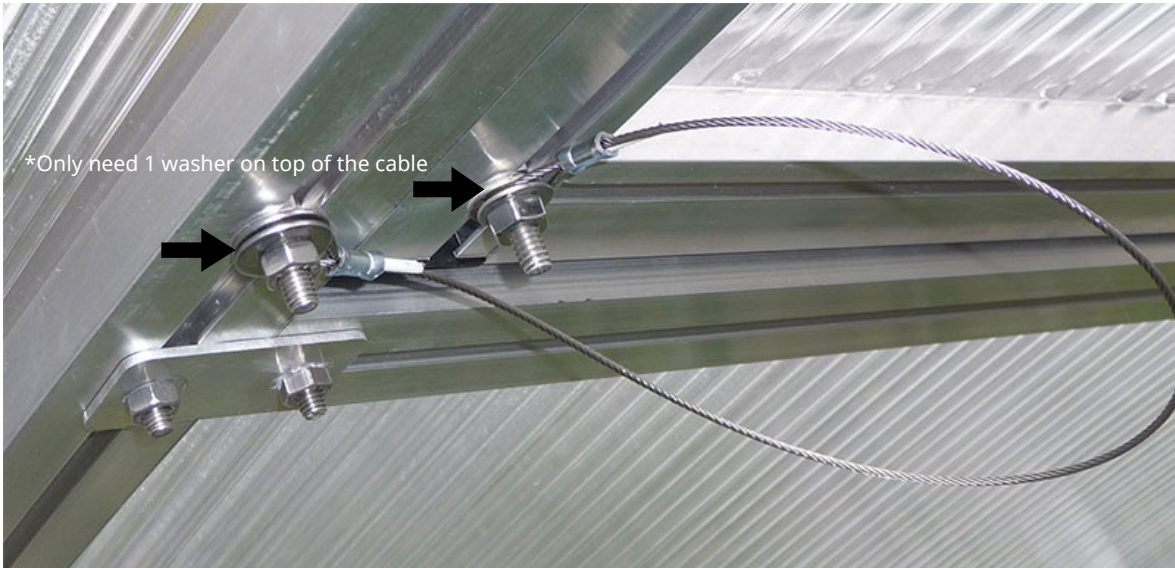

Two restraints are used for each window; one on each side of the window. Install each loop between two flat washers on screws inserted into the channel. Position the restraint as illustrated and adjust as needed to avoid interference from the crossbar as the window is raised and lowered.







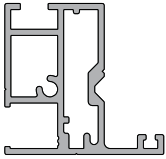

You can make your own restraints from $\frac{1}{16}$ " stainless wire rope, stranded 7x19 for maximum flexibility. Overall length should be about 16". When installed near the crossbar, they will limit the window opening to less than the safe extents of the hinge and window opener, but greater than the maximum thermal extent of the opener. More important than the exact length of the restraint is a close length match for each window's pair. If you are not equipped to swage the binding sleeves you can use wire rope clamps.



Profiles for divided revolving door - bottom -

overview	pos.	description		num-ber	length in mm
	5.3.1	door profile bottom		1	700mm/27 ⁹ / ₁₆ "
	5.6	door profile left	with hole for sash lock	1	692mm/27 ¹ / ₄ "
	5.7	door profile right	with hinge hole	1	692mm/27 ¹ / ₄ "
	5.9	door profile top	with transverse hole	1	700mm/27 ⁹ / ₁₆ "
	5.8	square tube	with transverse hole	1	740mm/29 ¹ / ₈ "

Content accessories bag divided revolving door - bottom -

overview	pos.	description		num-ber	length in mm
	V51	metal hinge, black	item no 9999 0358	2	
	V28	sash lock	item no 9999 0023	1	
	V29	QR-stopper 30 x 30 x 1,5-2	item no 9999 0099	2	
	V25	T-seal	item no 9999 0032	2 2	710mm/27 ¹⁵ / ₁₆ " 744mm/29 ⁵ / ₁₆ "
	S18	screw countersunk head 4,8 x 25 (hinges)	item no 9999 0163	8	
	S17	screw countersunk head 4,2 x 45 (doors)	item no 9999 0160	4	
	S19	screw countersunk head 3,5 x 22 (sash lock)	item no 9999 0152	2	
	S6	pan head screw 3,5 x 38 (square tube)	item no 9999 0138	2	
	V32	glazing block 30 x 10 x 4		2	
	V30/ V31	corner bracket door profil	left - item no 9999 0009 right - item no 9999 0011	4	

* **Note:** The seal is bundled in one strand for all doors and windows, please cut accordingly.

Assembly - divided revolving door - bottom -

view from outside

Lay the profiles out like the diagram below (possibly on cardboard or something similar).

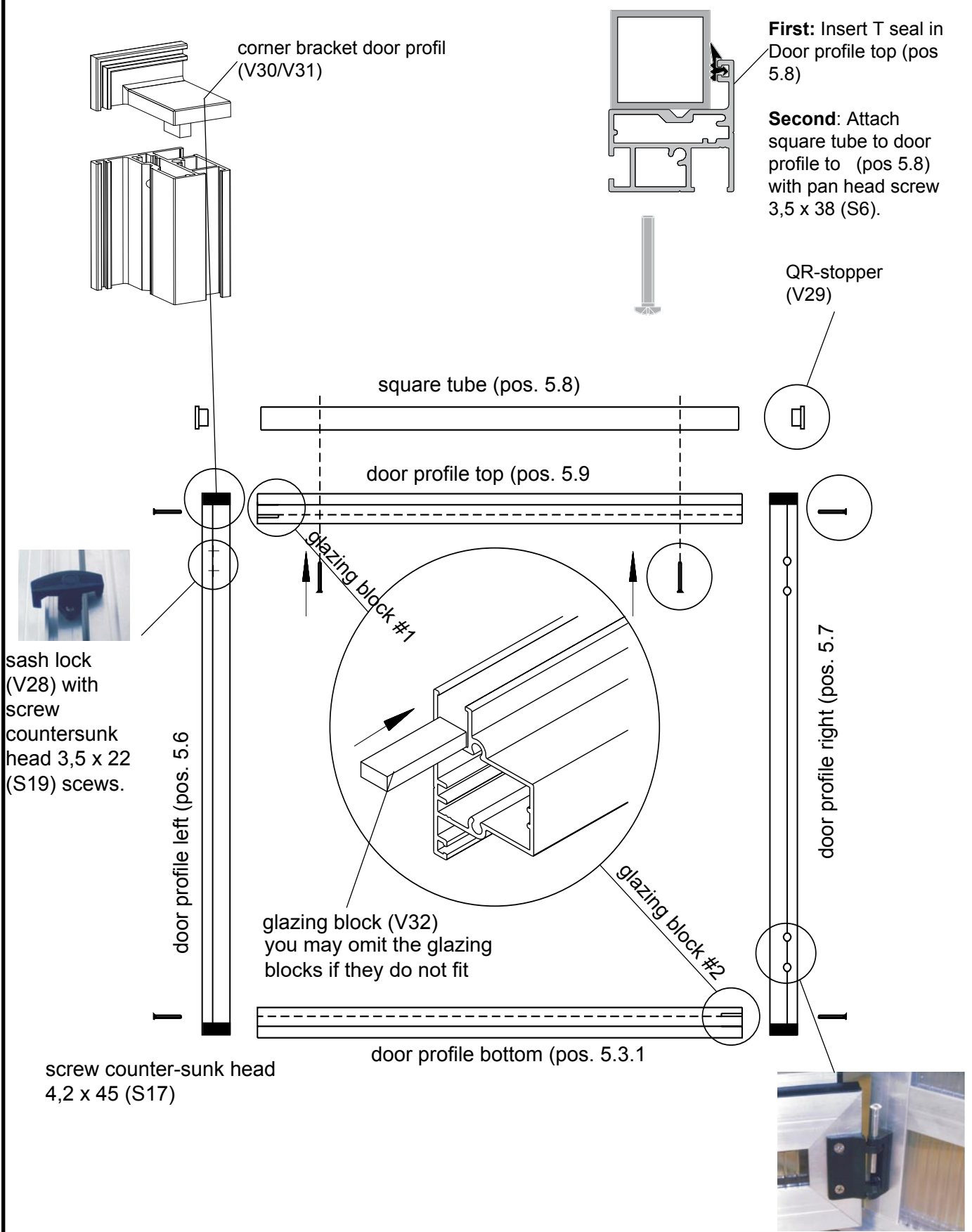





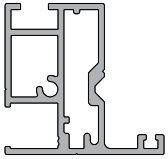
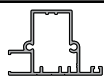





* **Note:** The seal is bundled in one strand for all doors and windows, please cut accordingly.

Profiles for divided revolving door - top -

overview	pos.	description	number/length in mm	
			Riga S	Riga
	5.1	door profile left	1 1081mm 42 9/16 "	1 1264mm 49 3/4 "
	5.2	door profile right with hinge hole	1 1081mm 42 9/16 "	1 1264mm 49 3/4 "
	5.3	door profile top	1 700mm 27 9/16 "	1 700mm 27 9/16 "
	5.4.1	cross bar with hole for lockable door handle	1 700mm 27 9/16 "	1 700mm 27 9/16 "

Content accessories bag - divided revolving door - top

overview	pos.	description	number/length in mm	
			Riga S	Riga
	V52	door handle, lockable outside - item no 9999 0035 inside - item no 9999 0244	1	1
	S17	screw countersunk head 4,2 x 45 (door) item no 9999 0160	6	6
	V32	glazing block 30 x 10 x 4	2	2
	V25	T-seal item no 9999 0032	2 710mm 27 15/16 "	2 710mm 27 15/16 "
	V51	metal hinge, black item no 9999 0358	2	2
	S18	screw countersunk head 4,8 x 25 (hinge) item no 9999 0163	8	8
	V28	sash lock, small item no 9999 0023	1	1
	S19	screw countersunk head 3,5 x 22 (sash lock) item no 9999 0152	2	2
	V33	door locking device item no 9999 0230	1	1
	S22	wing-type self drill, screw counters head 3,5 x 13 (door stop) item no 9999 0189	1	1
	V30/ V31	corner bracket door profil left - item no 9999 0009 right - item no 9999 0011	2	2

* **Note:** The seal is bundled in one strand or all doors and windows, please cut accordingly.

Assembly - divided revolving door - top -

view from outside

Place the profiles on the ground or a flat surface like the diagram below (possibly on cardboard or something similar).

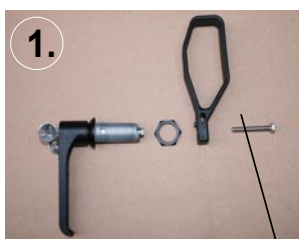
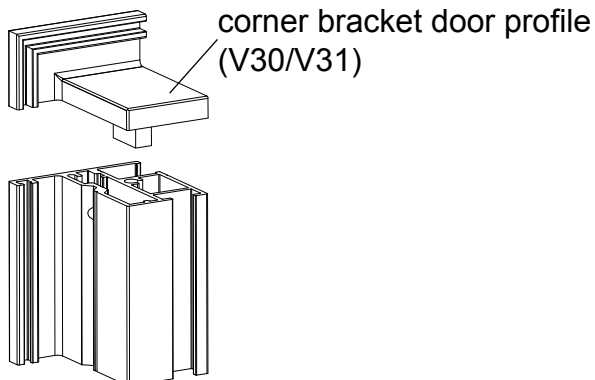

Assembly of door handle

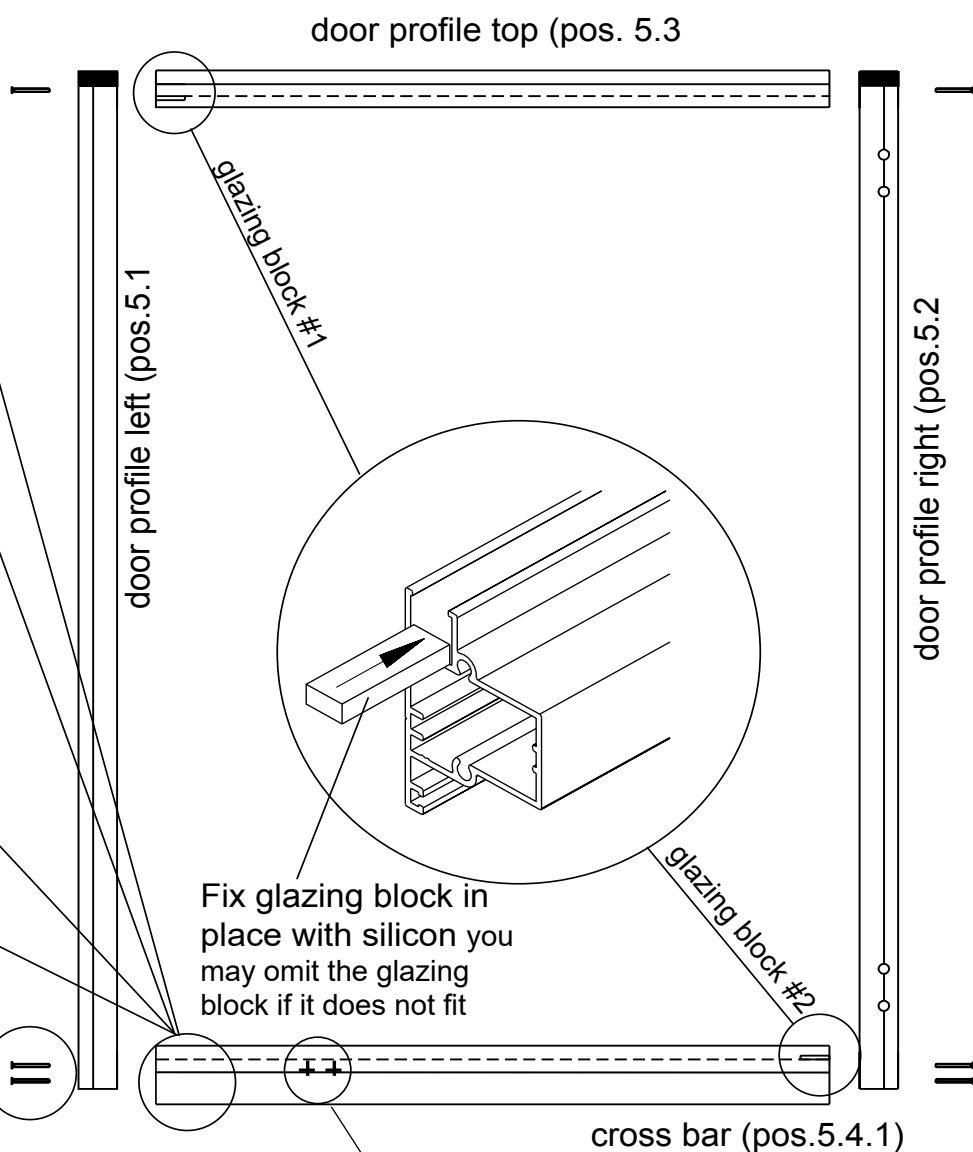

screw countersunk head 4,2 x 45 (S17)

sash lock (V28) with screw countersunk head 3,5 x 22 (S19) screws



* **Note:** The seal is bundled in one strand for all doors and windows, please cut accordingly.

Installation of Door Catch

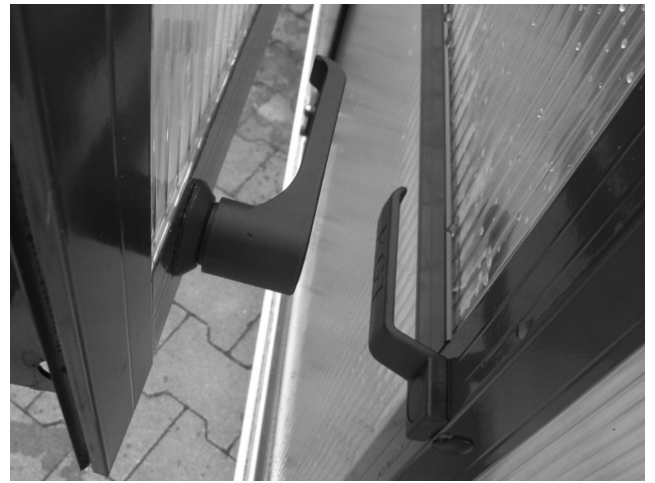
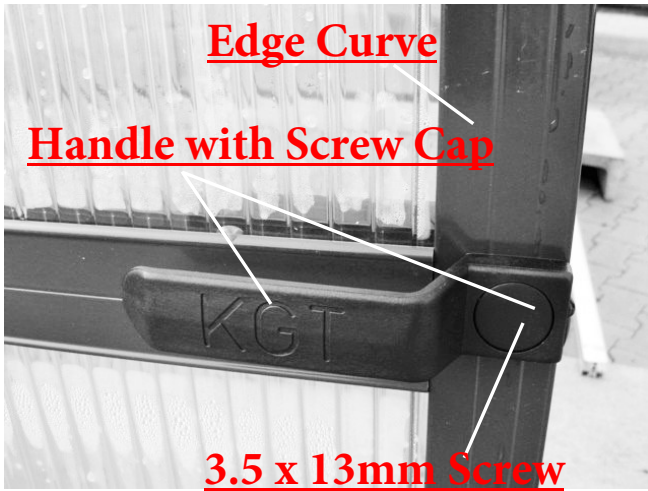

Door Catch Placement Riga Model IIs, IIIs, IVs

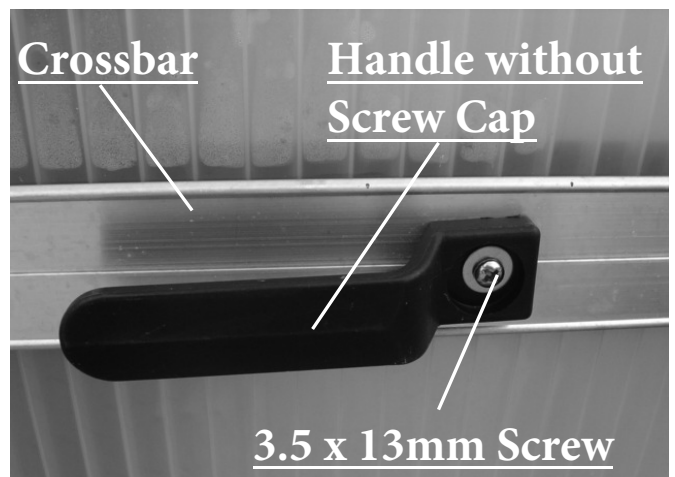
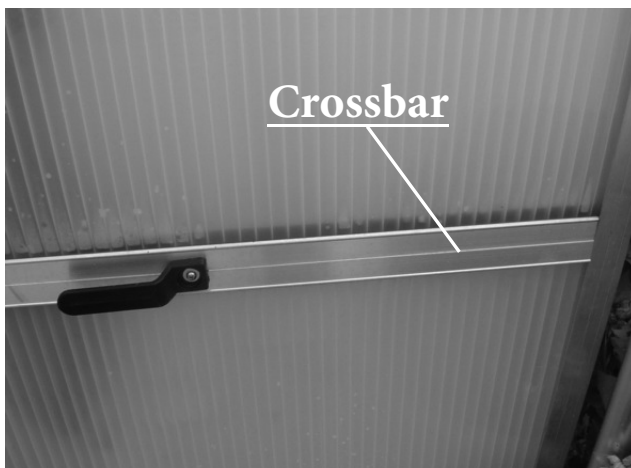

Door Catch Placement Riga Model III, IV, V

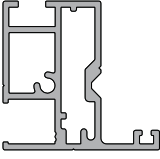

Profiles for rear window

overview	pos.	description		number/length in mm	
				Riga S	Riga
	5.1.2	door profile left	with hole for sash lock	1 1081mm 42 9/16 "	1 1264mm 49 3/4 "
	5.2	door profile right	with hinge hole	1 1081mm 42 9/16 "	1 1264mm 49 3/4 "
	5.3.1	door profile top		1 700mm 27 9/16 "	1 700mm 27 9/16 "
	5.4.2	door profile bottom	with hole for window opener	1 700mm 27 9/16 "	1 700mm 27 9/16 "

Content accessories bag - rear window -

overview	pos.	description	number/length in mm	
			Riga S	Riga
	S17	screw countersunk head 4,2 x 45 (window) item no 9999 0160	6	6
	V32	glazing block 30 x 10 x 4	2	2
	V25	T-seal item no 9999 0032	2 710mm 27 15/16 "	2 710mm 27 15/16 "
			2 1112mm 43 3/4 "	2 1295mm 51 "
	V51	metal hinge, black item no 9999 0358	2	2
	S18	screw countersunk head 4,8 x 25 (hinges) item no 9999 0163	10	10
	V28	sash lock, small item no 9999 0023	1	1
	S19	screw countersunk head 3,5 x 22 (sash lock) item no 9999 0152	2	2
	V85	opener for rear window item no 9999 0303	1	1
	V145	corner (fixation of window) item no 9999 0416	1	1
	S9	screw pan head 4,2 x 13 item no 9999 0144	2	2
	V30/ V31	corner bracket door profil left - item no 9999 0009 right - item no 9999 0011	2	2
	S12/ S1	hexagonal screw M6 x 12 with nut M6 item no 9999 0124 item no 9999 0128	4	4

* **Note:** The seal is bundled in one strand for all doors and windows, please cut accordingly.

Assembly - rear window -

view from outside

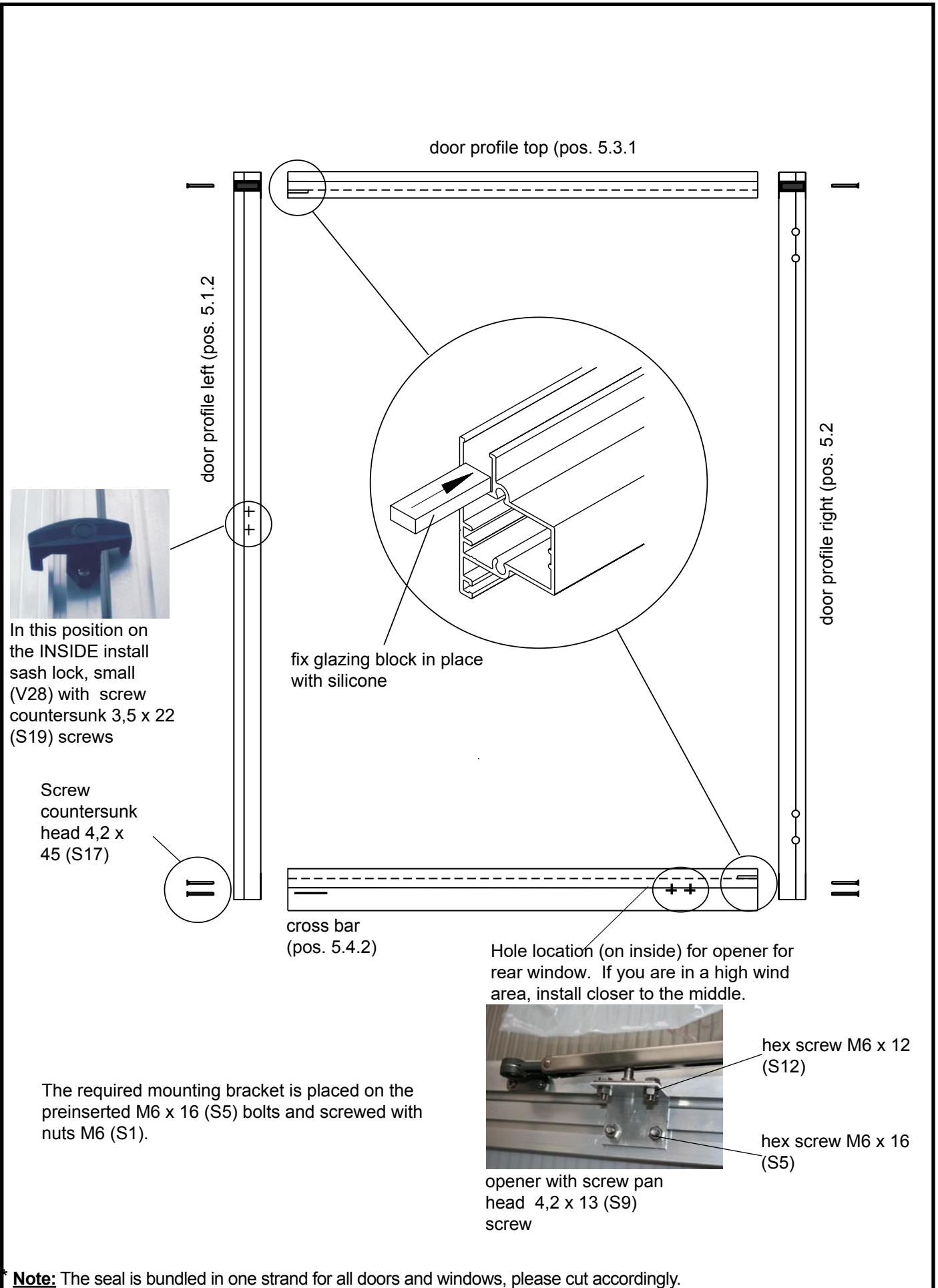

* **Note:** The seal is bundled in one strand for all doors and windows, please cut accordingly.

Assembly procedure - eaves -

ATTENTION! When using a foundation frame attach it to the soil profile before these steps (see pages 5, 6)

step 8

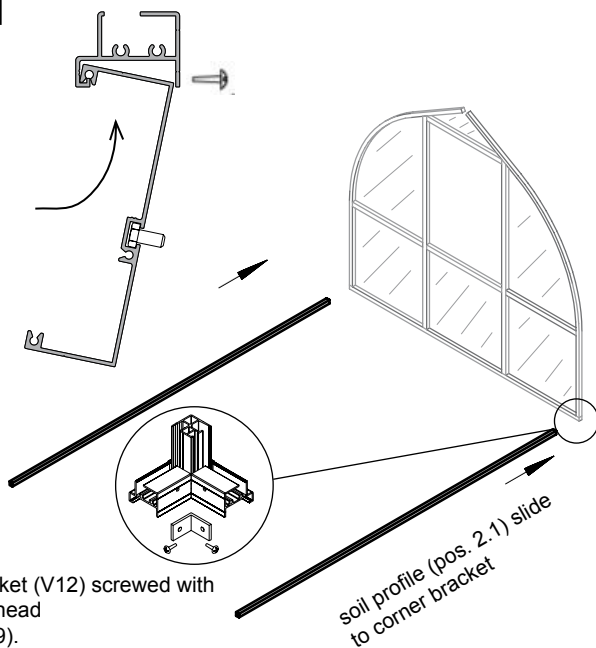

to step 8:

Note: If you have purchased a foundation frame attach it to the soil profiles before you attempt this step.

First attach the soil profiles(pos 2.1) to the end gables with the preinstalled corner connectors(V9).

Next screw the corner bracket (V12) to the gable end soil profile and the side soil profile. This will secure the gable end to the side wall.

step 9

ridge profile (pos. 3.3) at the gable and end plate (V11) screw with screw pan head 4,2 x 13 (S9)

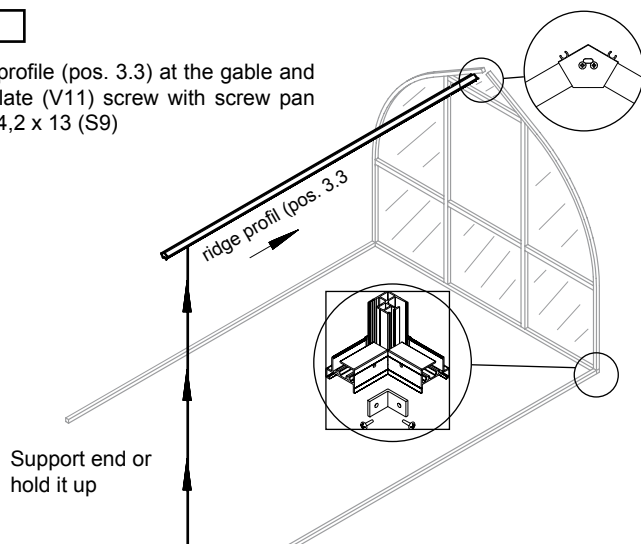

to step 9:

Some assistance will be needed for the following steps.

We recommend you have someone stand on a ladder and hold one end of the ridge profile while you proceed with the rest of the assembly. You could also construct a support to hold it in place.

Slide the unsupported end of the ridge profile into the grooves/slots in the top of the gable end. The top portion of the ridge profile should be flush with the outside of the gable end. Now attach the end plate(V11) with pan head screws 4.2 x 13 (S9)

step 10

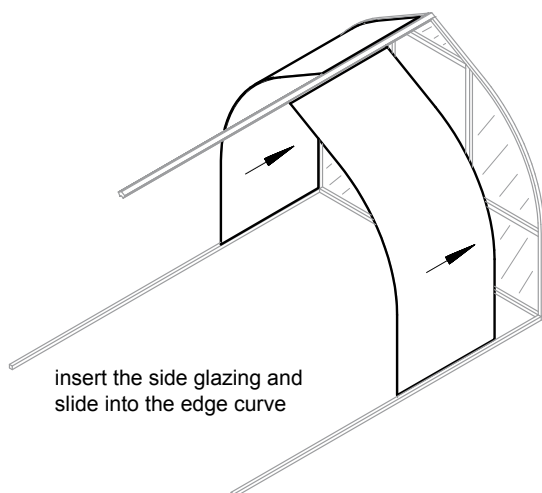

to step 10:

Insert the glazing in the ridge beam and the soil profile. Then slide it into the Edge Curve.

Tip:

Peel back the protective film on the glazing only around the edges. This will prevent the panels from getting scratched.

It is also a good idea to attach a stabilization angle (pos 3.4) to each of the side curves as you go along. This will help hold everything together.

Assembly procedure - eaves -

ATTENTION! When using a foundation frame assemble in advance on this soil profile (see pag s 5,

step 11

shown enlarged
side curve (pos. 2.3)

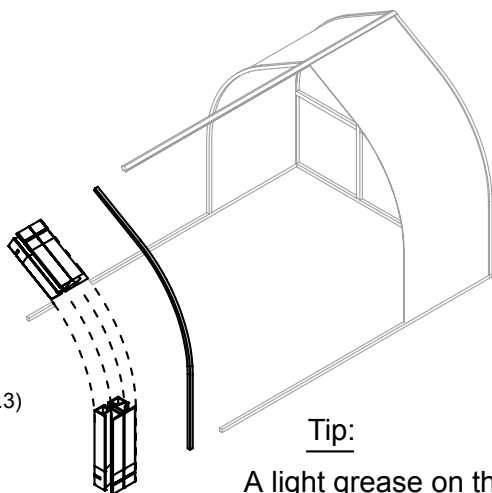

Tip:

A light grease on the plastic sliders may help movement.

to step 11:

First place a side curve up against the edge curve installed on the gable end. You want to match curvature of the edge curve with the side curve. This will ensure that the side curve is installed in the correct direction.

Slide the side curve (pos 2.3) into the ridge profile and into the soil profile. Work it down until it is flush with the glazing then work the glazing into it.

If necessary you can use a rubber mallet on the side curve to move it down. Be careful not to damage the aluminum.

step 12

Use silicone to seal the end of the crossbar where it meets the curve profile.

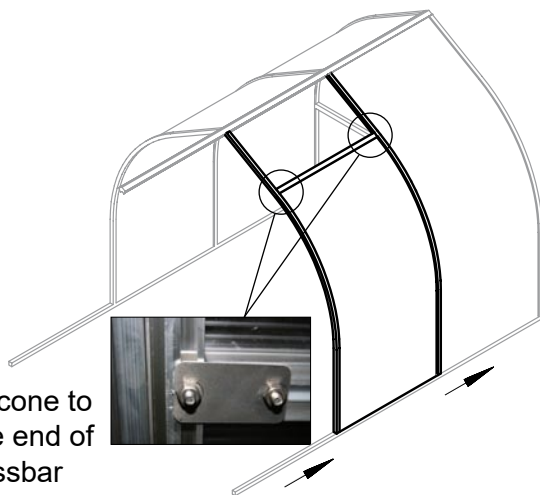

to step 12:

Continue inserting the side glazing and side curves.

The connecting plate (V4) is attached from the inside with screw hex M6 x 16 and nut M6. This secures the window crossbar to the greenhouse.

step 13

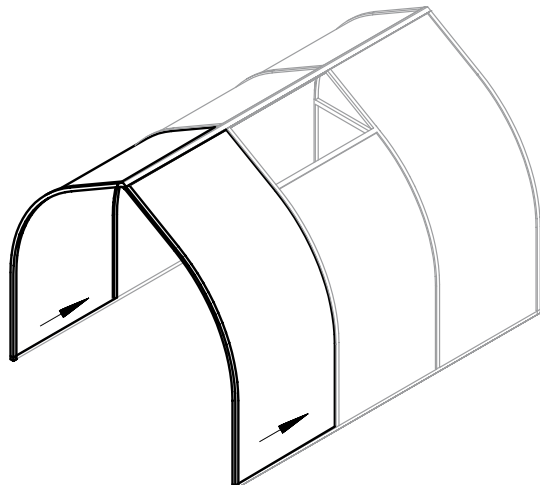

to step 13:

Insert the remaining glazing panels and side curves.

Assembly procedure -eaves-

ATTENTION! When using a foundation frame attach it to soil profile in advance (see pages 5, 6)

step 14

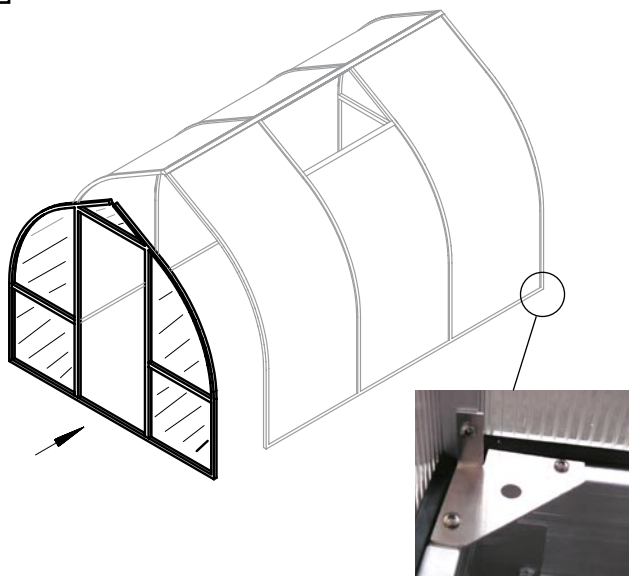

to step 14:

Attach the preassembled door gable. Refer to steps 8-9 for attachment procedures.

For added stability install the inside corner (V1). Use the screw pan head 4,2 x 13 (S9).

step 15

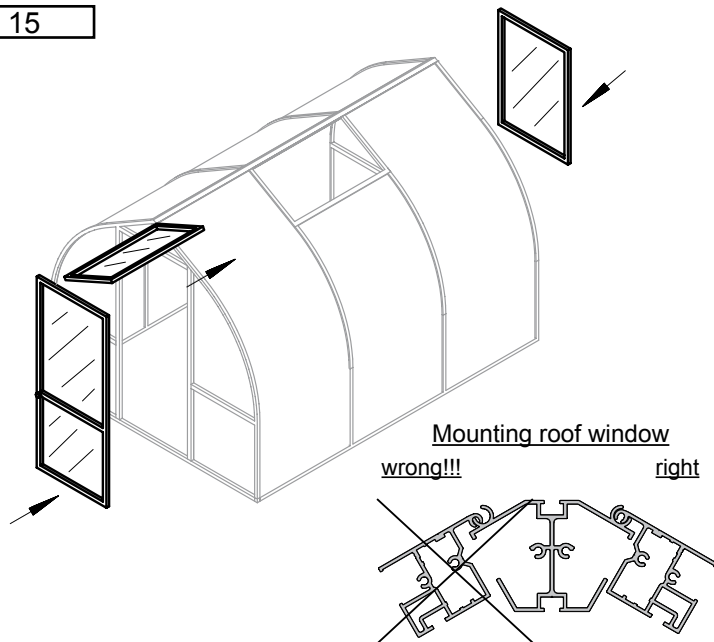

to step 15:

Install the door and windows. Instructions, see page 12-21.

step 16

Glazing cut away in image to show installation.

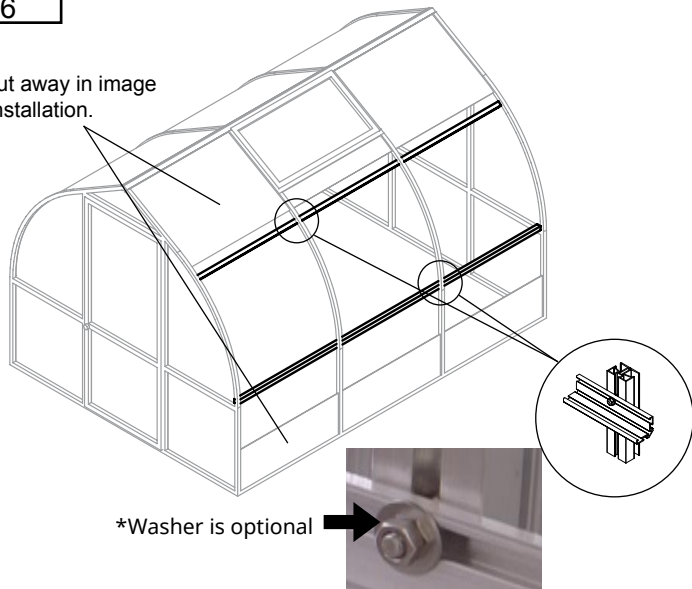



to step 16:

The stabilization angle (pos 3.4) is installed on both sides from inside. It is attached to the side curve with screw M6 x 16, nut M6 and washer A6, 4 screwed.

The stabilization angles (pos 3.4) are also the rear supports for the top and bottom shelf (see separate instructions).

Step 17: Insert wedge gaskets on the inside of greenhouse where the polycarbonate meets the soil profile (see p. 4). Once this is done, seal horizontal exterior surfaces with silicon (see p. 5)

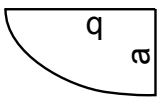
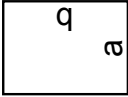
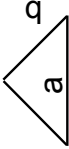
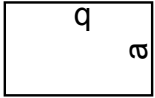
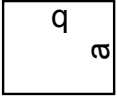
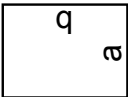
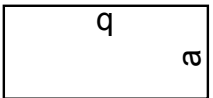
Polycarbonate Glazing Size Sheet

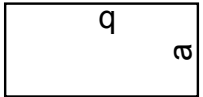
type of house	gable above	gable below	gable triangular	door/window	div. revolv. door/bottom	rear gable below	side glazing	roof window	below roof window
									
	number size (a x b)	number size (a x b)	number size (a x b)	number size (a x b)	number size (a x b)	number size (a x b)	number size (a x b)	number size (a x b)	number size (a x b)
Riga II S	4 730 x 1135 ^{mm} 28 ^{3/4} X 44 ^{11/16} "	4 730 x 728 ^{mm} 28 ^{3/4} X 28 ^{11/16} "	2 779 x 239 ^{mm} 30 ^{11/16} X 9 ^{7/16} "	2 724 x 1031 ^{mm} 28 ^{1/2} X 40 ^{9/16} "	1 724 x 676 ^{mm} 28 ^{1/2} X 26 ^{9/8} "	1 787 x 728 ^{mm} 31 X 28 ^{11/16} "	3 1048 x 2634 ^{mm} 41 ^{1/4} X 103 ^{11/16} "	1 974 x 565 ^{mm} 38 ^{3/8} X 22 ^{1/4} "	1 1048 x 1984 ^{mm} 41 ^{1/4} X 78 ^{1/8} "
Riga III S	4 730 x 1135 ^{mm} 28 ^{3/4} X 44 ^{11/16} "	4 730 x 728 ^{mm} 28 ^{3/4} X 28 ^{11/16} "	2 779 x 239 ^{mm} 30 ^{11/16} X 9 ^{7/16} "	2 724 x 1031 ^{mm} 28 ^{1/2} X 40 ^{9/16} "	1 724 x 676 ^{mm} 28 ^{1/2} X 26 ^{9/8} "	1 787 x 728 ^{mm} 31 X 28 ^{11/16} "	5 1048 x 2634 ^{mm} 41 ^{1/4} X 103 ^{11/16} "	1 974 x 565 ^{mm} 38 ^{3/8} X 22 ^{1/4} "	1 1048 x 1984 ^{mm} 41 ^{1/4} X 78 ^{1/8} "
Riga IV S	4 730 x 1135 ^{mm} 28 ^{3/4} X 44 ^{11/16} "	4 730 x 728 ^{mm} 28 ^{3/4} X 28 ^{11/16} "	2 779 x 239 ^{mm} 30 ^{11/16} X 9 ^{7/16} "	2 724 x 1031 ^{mm} 28 ^{1/2} X 40 ^{9/16} "	1 724 x 676 ^{mm} 28 ^{1/2} X 26 ^{9/8} "	1 787 x 728 ^{mm} 31 X 28 ^{11/16} "	6 1048 x 2634 ^{mm} 41 ^{1/4} X 103 ^{11/16} "	2 974 x 565 ^{mm} 38 ^{3/8} X 22 ^{1/4} "	2 1048 x 1984 ^{mm} 41 ^{1/4} X 78 ^{1/8} "
Riga III	4 1048 x 1319 ^{mm} 41 ^{1/4} X 51 ^{15/16} "	4 1048 x 728 ^{mm} 41 ^{1/4} X 28 ^{11/16} "	2 779 x 239 ^{mm} 30 ^{11/16} X 9 ^{7/16} "	2 724 x 1215 ^{mm} 28 ^{1/2} X 47 ^{13/16} "	1 724 x 676 ^{mm} 28 ^{1/2} X 26 ^{9/8} "	1 787 x 728 ^{mm} 31 X 28 ^{11/16} "	5 1048 x 3000 ^{mm} 41 ^{1/4} X 118 ^{11/16} "	1 974 x 565 ^{mm} 38 ^{3/8} X 22 ^{1/4} "	1 1048 x 2345 ^{mm} 41 ^{1/4} X 92 ^{5/16} "
Riga IV	4 1048 x 1319 ^{mm} 41 ^{1/4} X 51 ^{15/16} "	4 1048 x 728 ^{mm} 41 ^{1/4} X 28 ^{11/16} "	2 779 x 239 ^{mm} 30 ^{11/16} X 9 ^{7/16} "	2 724 x 1215 ^{mm} 28 ^{1/2} X 47 ^{13/16} "	1 724 x 676 ^{mm} 28 ^{1/2} X 26 ^{9/8} "	1 787 x 728 ^{mm} 31 X 28 ^{11/16} "	6 1048 x 3000 ^{mm} 41 ^{1/4} X 118 ^{11/16} "	2 974 x 565 ^{mm} 38 ^{3/8} X 22 ^{1/4} "	2 1048 x 2345 ^{mm} 41 ^{1/4} X 92 ^{5/16} "
Riga V	4 1048 x 1319 ^{mm} 41 ^{1/4} X 51 ^{15/16} "	4 1048 x 728 ^{mm} 41 ^{1/4} X 28 ^{11/16} "	2 779 x 239 ^{mm} 30 ^{11/16} X 9 ^{7/16} "	2 724 x 1215 ^{mm} 28 ^{1/2} X 47 ^{13/16} "	1 724 x 676 ^{mm} 28 ^{1/2} X 26 ^{9/8} "	1 787 x 728 ^{mm} 31 X 28 ^{11/16} "	6 1048 x 3000 ^{mm} 41 ^{1/4} X 118 ^{11/16} "	4 974 x 565 ^{mm} 38 ^{3/8} X 22 ^{1/4} "	4 1048 x 2345 ^{mm} 41 ^{1/4} X 92 ^{5/16} "



Optional Accessory







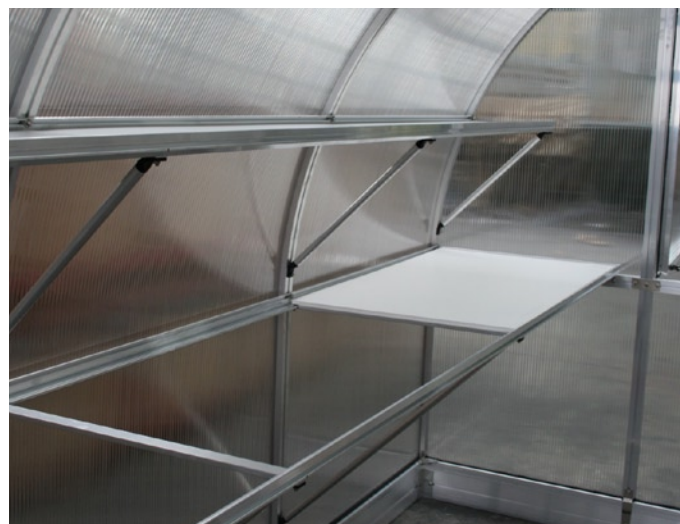

Riga / Riga S

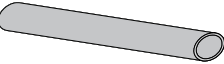
Top Shelf Assembly Instructions

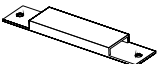
Shelf assembly animation is available at the end of our Riga Greenhouse assembly video on our Exaco You Tube page.



Parts List for Top Shelf:

Description	pos.	overview	Riga II	Riga III/IIIS	Riga IV/IVS	Riga V/VS
longitudinal profile	1		2	2	3	4
strut (Ø20 x 1,5) - 32 inches	3		3	4	5	6
angle-end tail (narrow)	V36		6	8	10	12
cross-brace	5		3	4	5	6
connector with grub screw	V161		2	2	4	6
hexagonal screw M6 x 12 with nut M6	S12/ S1		3	4	5	6
hexagonal screw M6 x 16 with nut M6	S5/ S1		3	4	5	6
T-head bolt M6 x 16 with nut M6	S15/ S1		3	4	5	6
Allen key	V21		1	1	1	1
Polycarbonate sheets (shelf surface) In a separate box			2	3	4	5

Before beginning step 1 of assembly, take time to prepare your longitudinal profile:

Connect your longitudinal profiles using connectors with grub screws (may be preinserted into your longitudinal profile).

The sections of longitudinal profiles (pos 1) are connected with connectors with grub screws (V161) as shown to the left. Tighten the set screws/grub screws with included Allen wrench.



Riga II	1x 2104 mm (82.8 inches)
Riga III	1x 3162 mm (124.5 inches)
Riga IV	1x 4220 mm (166.1 inches)
Riga V	1x 5278 mm (207.8 inches)

Assembly Overview:

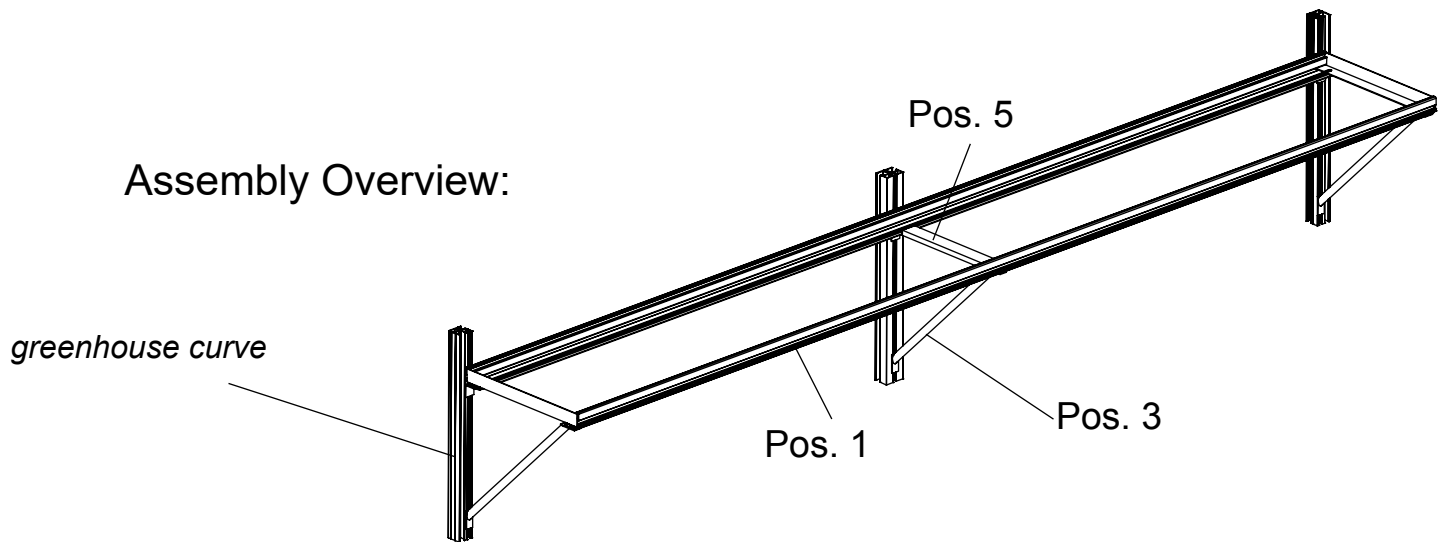

Step 1



Attach an angle-end tail (V36) to each end of the struts (pos. 3). Push in as far as it will possibly go - it is okay if it does not fully insert.

Step 2

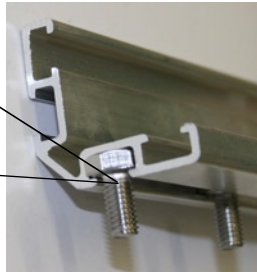
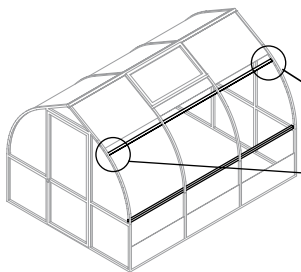

Insert one M6 x 12 bolt (S12) per greenhouse curve (including edge curves) into the lower bottom channel of the attached greenhouse lateral support.

Step 3



Insert one M6 x 12 bolt (S12) per curve of greenhouse (including the edge curves) into the lower channel on the bottom of the longitudinal profile (pos.1) of the shelf kit. Tip: Use a strip of tape to keep the bolts from sliding out the end.

Step 4



Attach the cross-braces (pos. 5) to the greenhouse lateral support with inserted bolt and nut and let them hang.

Step 5



Attach crossbrace to front longitudinal profile (from shelf kit) with inserted bolt. Add the strut assembly beneath and tighten with nut. Repeat on all curves.

Step 6



Attach strut to greenhouse curve with bolt (S5) and nut (S1). Tip: Insert bolt (S5) at the insertion point near the bottom of the curve. Please note that the black angle may not match the angle of your greenhouse curve.

Step 7



Finally, insert the polycarbonate panels

Optional Accessory





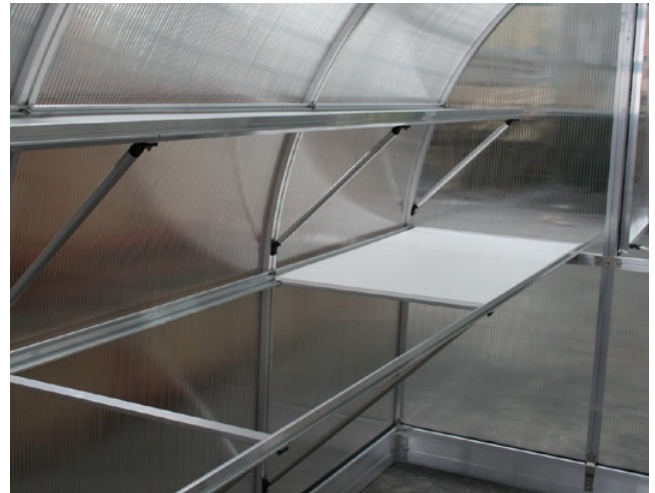

Riga/Riga S

Table Shelf Assembly Instructions

Shelf assembly animation is available at the end of our Riga Greenhouse assembly video on our Exaco YouTube page.

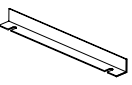
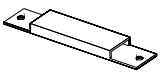

Parts List for Table Shelf

Description	pos.	overview	Riga II	Riga III/IIIS	Riga IV/IVS	Riga V/VS
longitudinal profile	1		2	2	3	4
cross-profile	2		2	2	2	2
strut (Ø20 x 1,5) - 18 inches	3		1	2	3	4
angle-end tail (narrow)	V36		2	4	6	8
cross-brace	5		1	2	3	4
angle	6		2	2	2	2
connector with grub screw	V161		2	2	4	6
hexagonal screw M6 x 12 with nut M6 (Shorter screw)	S12/ S1		7	8	9	10
hexagonal screw M6 x 16 with nut M6 (Longer screw)	S5/ S1		2	4	6	8
T-head bolt M6 x 16 with nut M6	S15/ S1		2	2	2	2
Allen key	V21		1	1	1	1
Polycarbonate sheets (shelf surface) In a separate box			2	3	4	5

Before beginning step 1 of assembly, take time to prepare your longitudinal profile:

Connect your longitudinal profiles using connectors with grub screws (may be pre-inserted into your longitudinal profile).

The sections of longitudinal profiles (pos 1) are connected with connectors with grub screws (V161) as shown to the left. Tighten the set screws/grub screws with included Allen wrench.

- Riga II 1x 2104 mm (82.8 inches)
- Riga III 1x 3162 mm (124.5 inches)
- Riga IV 1x 4220 mm (166.1 inches)
- Riga V 1x 5278 mm (207.8 inches)



Assembly Overview:

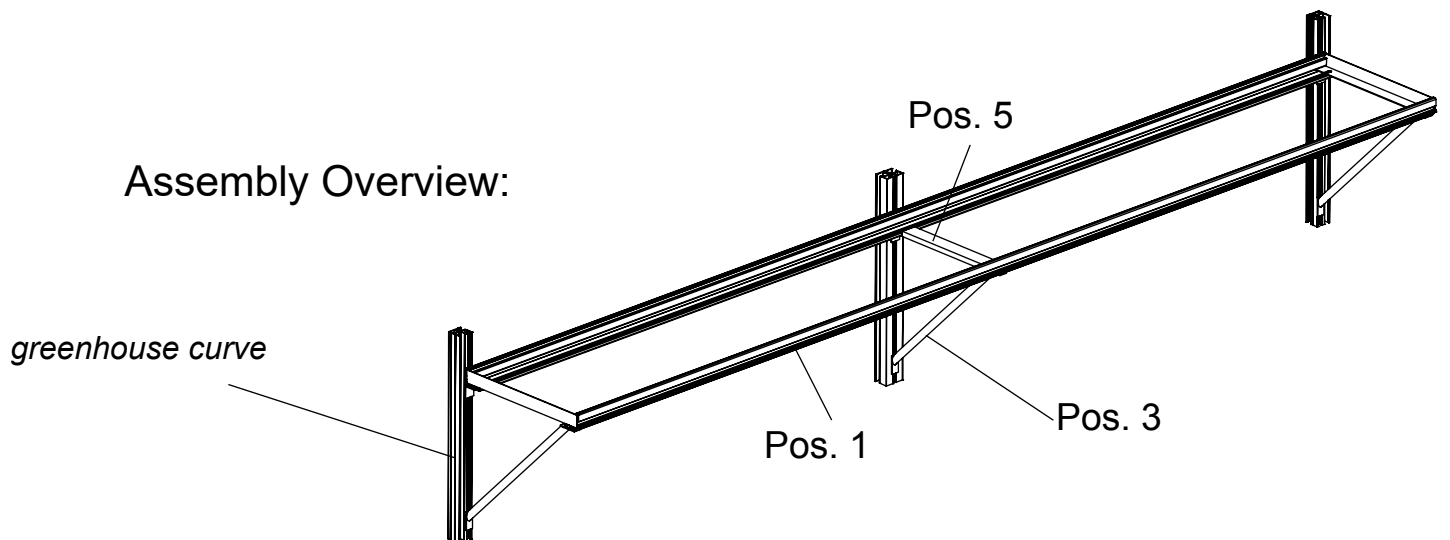

Riga Table Shelf Assembly

Step 1



Attach an angle-end tail (V36) to each end of the struts (pos. 3). Push in as far as it will possibly go - it is okay if it does not fully insert.

Step 2

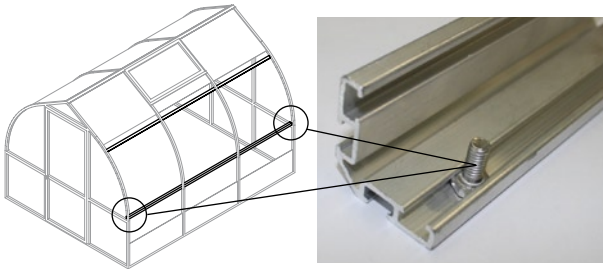

Insert one M6x12 bolt (pos S12) at each end of the greenhouse lateral support. These should be inserted into the lower inside channel of the lateral support as shown in picture.

Step 3

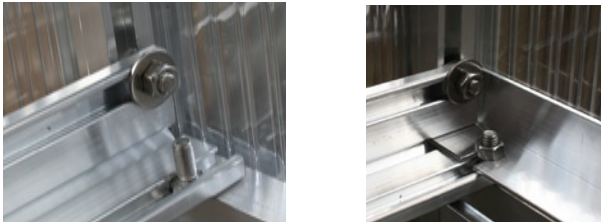

Lay the cross-profile (pos. 2) on top of the greenhouse lateral support and attach with supplied nuts (pos S1).

Step 4

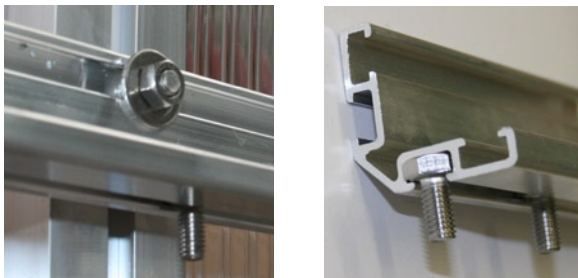

Insert one M6 x 12 bolt (S12) per inner curve of the greenhouse into the outer bottom channel on the greenhouse lateral support (already attached to your greenhouse).

Step 5

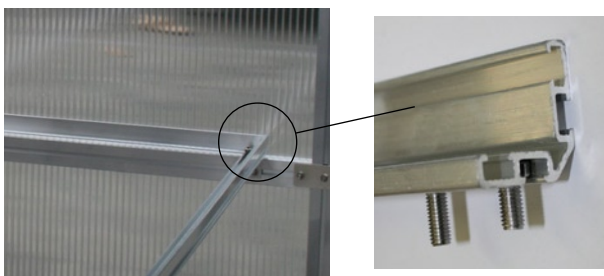

Insert one bolt M6 x 16 (S5) per inner curve into lower channel on the outside of the shelf longitudinal profile (pos 1). Insert one M6 x 12 bolt (S12) at each end for the angles (pos. 6). Tip: Use tape to prevent bolt from sliding out while handling.

Step 6



A. Attach the cross-braces (pos. 5) to the greenhouse lateral support with inserted bolt and nut and let them hang.

B. Rest ends of assembled longitudinal profile (pos 1) on the greenhouse gable crossbar. Then, starting at centermost curve, attach crossbrace to bolt in longitudinal profile (pos 1), attach strut assembly beneath and tighten with nut. Repeat at all inner curves.

Step 7



Use the T-head bolts (S15) to attach angle (pos 6) to greenhouse gable crossbar.

Step 8



Attach strut to greenhouse curve with bolt M6 x 16 (S5) and nut (S1). Use insertion point at black curve endcap to insert bolt heads into channel of the curve.

Step 9



Finally, insert the polycarbonate panels. At the gable ends, you may wish to trim around bolts/nuts that are holding the cross profile (pos. 2). Conversely, you may also just let the shelf rest on them.

Optional Accessory!

Exhaust Fan installation for RIGA XL, RIGA 4 & RIGA 5

If you have both an intake shutter vent and exhaust fan, you will want them to be opposite/diagonal from each other to get the best cross-breeze. Plug the fan into the thermostat (optional) to control when it turns on. If you are using both a shutter vent and an exhaust fan you will need to purchase a plug splitter and plug them both into the thermostat.

For a Riga 4 & 5, we recommend placing the exhaust fan next to rear wall window by placing the unit on top of the cross bar to support the weight, as seen below.

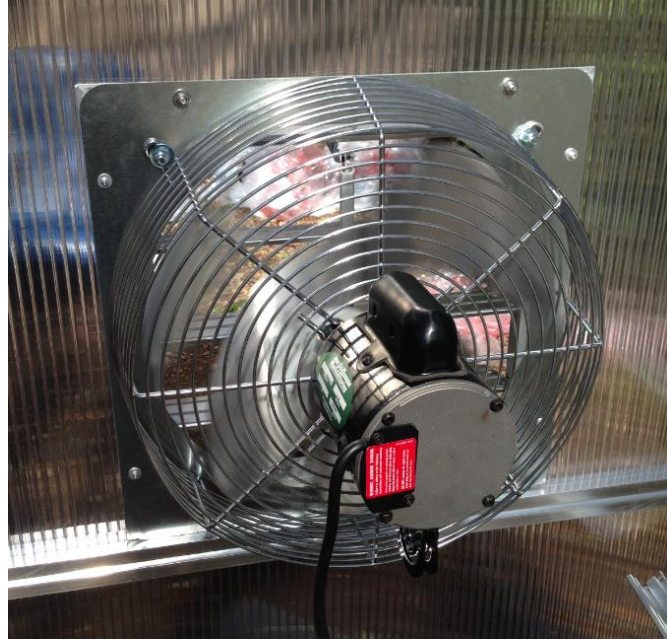

For the Riga XL the best placement is above the rear wall door with the weight on the door frame as seen to the left.

You may cut the hole in the polycarbonate before or after assembly of the greenhouse. Draw the outline of hole to be cut (only the area protruding from the polycarbonate). Drill a hole in each corner of the panel to insert a fine-tooth jigsaw blade and cut along the lines. Insert the fan. Drill holes in polycarbonate through the holes in the flange of the fan and hold in place with bolts – use washers on the outside. Once installed, we recommend caulking on the outside with neutral cure silicone caulk such as Boss 399.

Optional Accessory!

Intake Shutter Vent Installation for RIGA XL, RIGA 4 & RIGA 5

You will want your intake shutter vent to be opposite from your exhaust fan (i.e. opposite wall and lower part of the greenhouse) to get the best cross-breeze. They should both be plugged into the thermostat with a plug splitter to engage them simultaneously.

We recommend cutting a hole in the polycarbonate to bolt the intake shutter vent to the horizontal bar next to the front door. Measure the protruding dimensions and cut the appropriate size hole in the polycarbonate. You may cut this hole before installing the polycarbonate (see note to the right). If your greenhouse is assembled, the best way is to drill a hole in each of the corners of the section to be removed, then insert a jigsaw (fine tooth blade) to cut along your marked lines (note: if you use this method, your measurement will be different than the ones to the right).

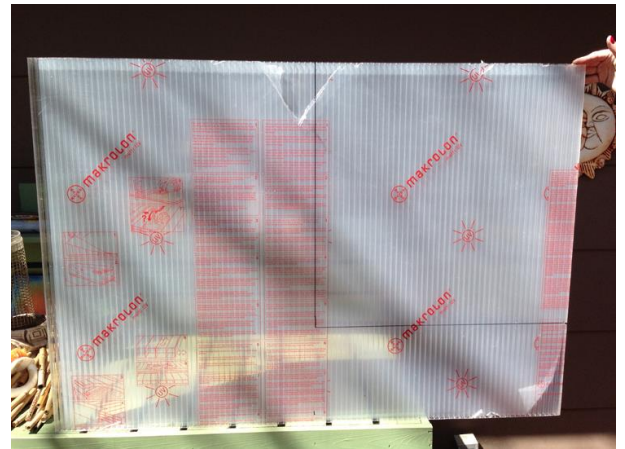

To cut the hole before installing the polycarbonate, you may use the following measurements as shown above:

- Riga 4: 16.75" w x 16.5" h
- Riga 5: 20.75" w x 20.5" h



Step 2: Bolt the “heavy/thick” L-bracket which comes with the vent to the galvanized steel “T-bracket” supplied by us, screw (self-tapping screws) the T-bracket to the bottom of the vent and cross bar (slightly off center). You may want to drill small pilot holes. Attach the “motor” to the “L-bracket” with the 4 black screws. Then follow the instructions provided with the vent. Attach the spring (only 1 is needed) to pull the vent closed at the top in a small hole drilled in the top flange. We have found that it is best to hook the chain over the top of the center bar to pull the vent open. We recommend sealing with a neutral cure silicone caulk (such as Boss 399) on the outside of the greenhouse.

OPTIONAL ACCESSORY: Riga Metal Hook Assembly





Customer Service or
Assembly Questions?

Give us a call
Toll free: 1-877-760-8500
customerservice@exaco.com
Exaco Trading
www.EXACO.com

*Please watch our animated assembly
video on our Exaco Trading Co
YouTube Channel.
Find the link at www.exaco.com*