

# Foundation instruction manual

99 ft<sup>2</sup> (9,2m<sup>2</sup>) Grillkota



# Foundation plan



**master-detail-screen:**

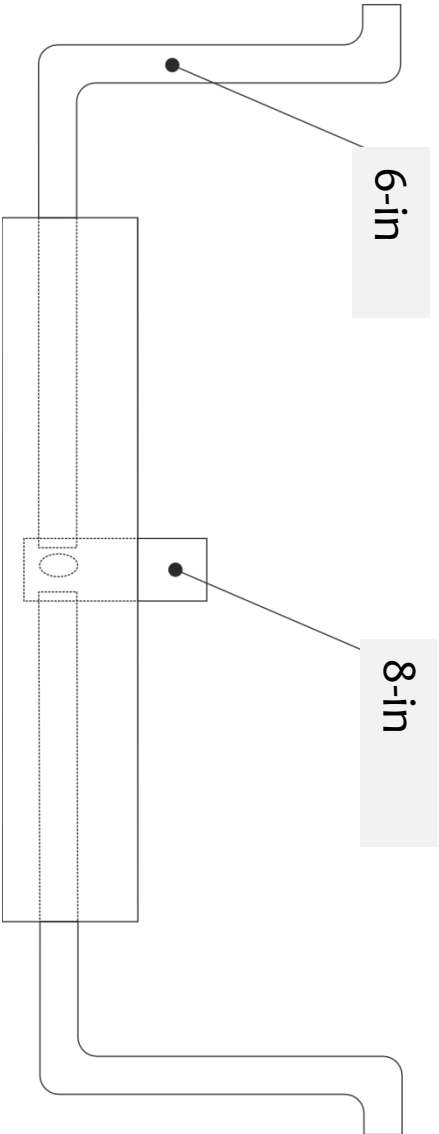

# Foundation plan

top view:

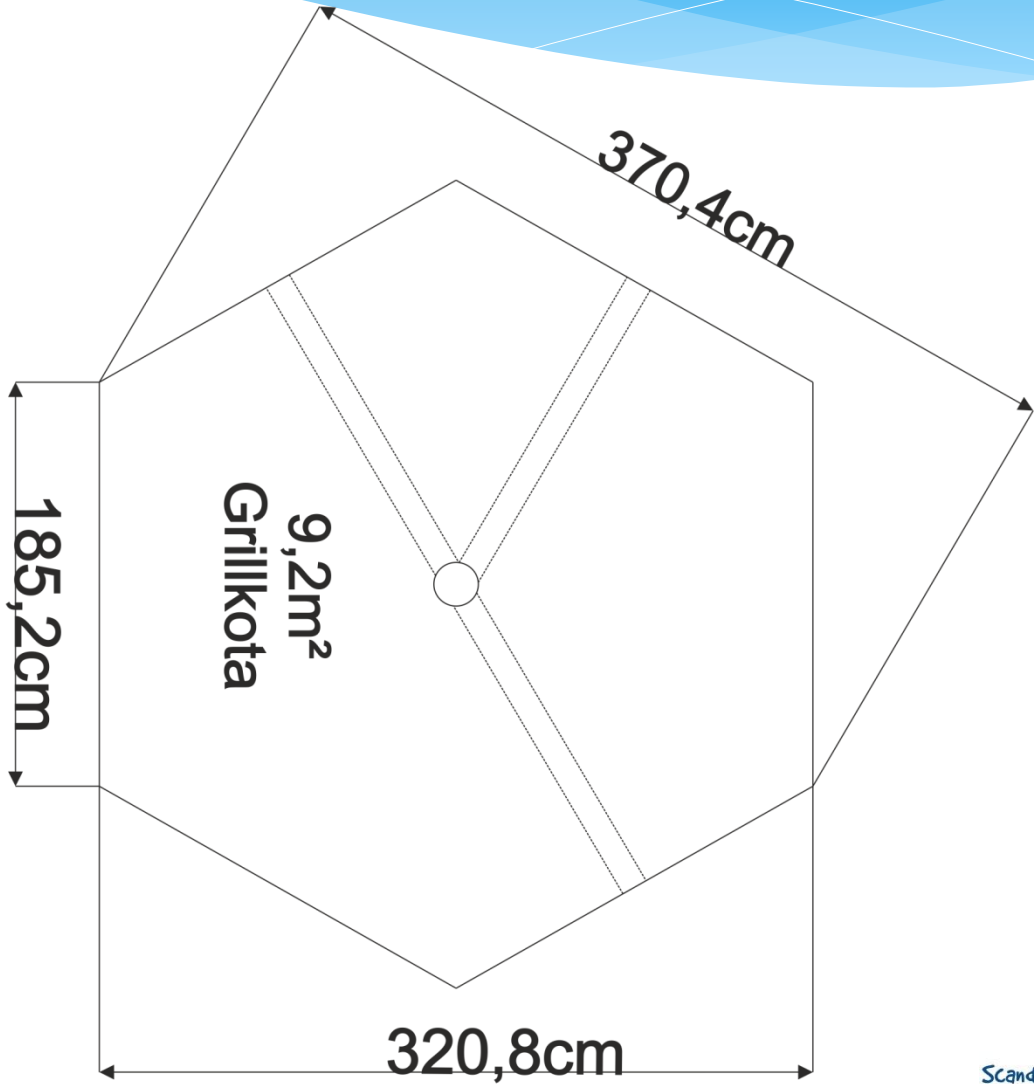

master-detail-screen:

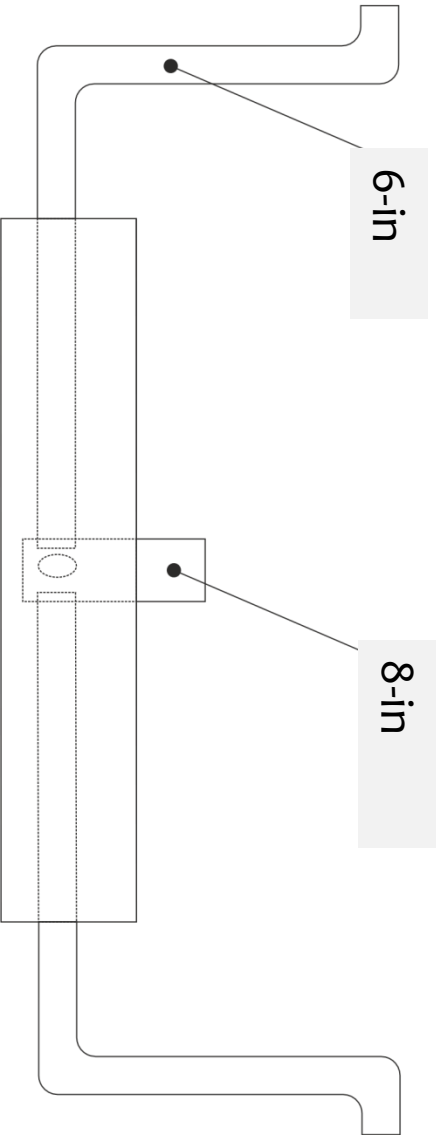

# Construction of a concrete foundation

Fig. 1

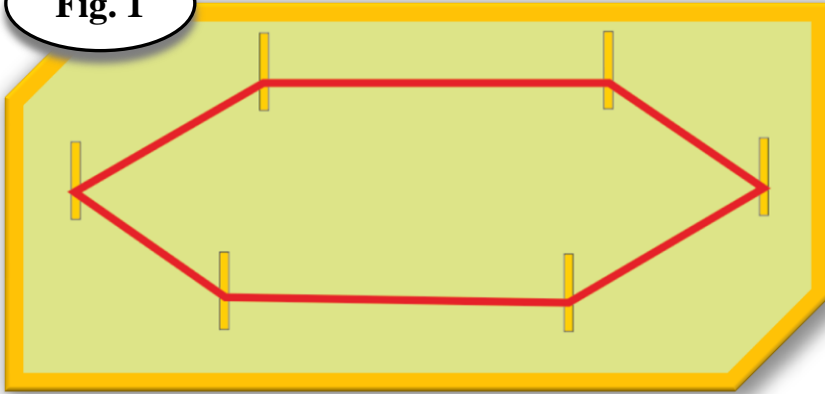

fig.1

Stake out the areal of where the foundation shall be placed. **(Use the Foundation plan from side 2.)**

Fig. 2

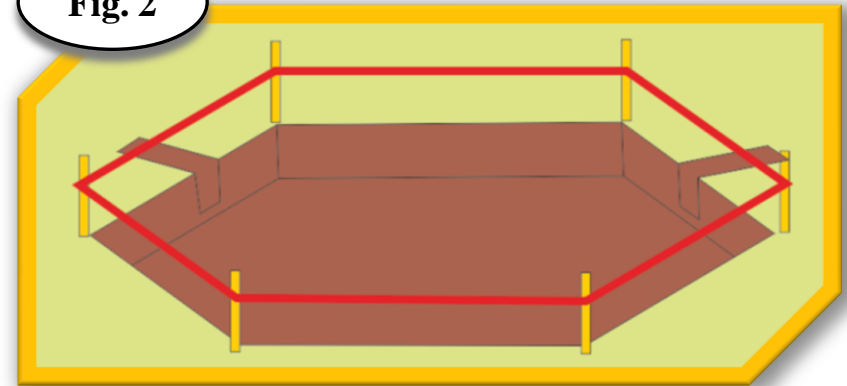

fig.2

Dig up around 12-16in (30-40cm) of soil, depending on the soil structure.

Fig. 3

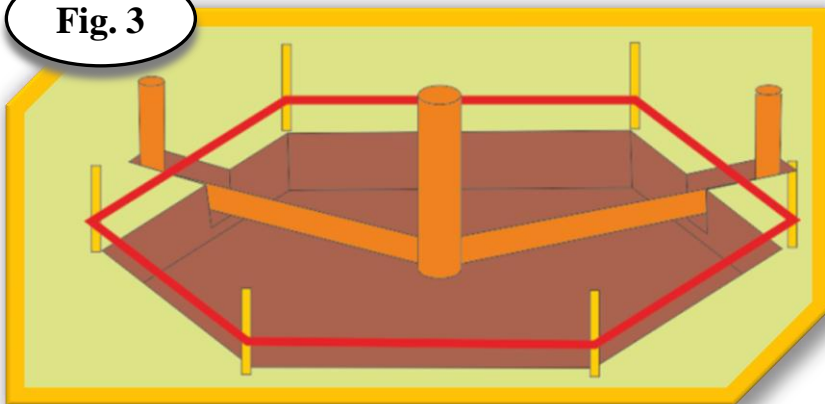

fig.3

Place the tubes as specified on page one of the manual. (see fig.)

# Construction of a concrete foundation

Fig. 4

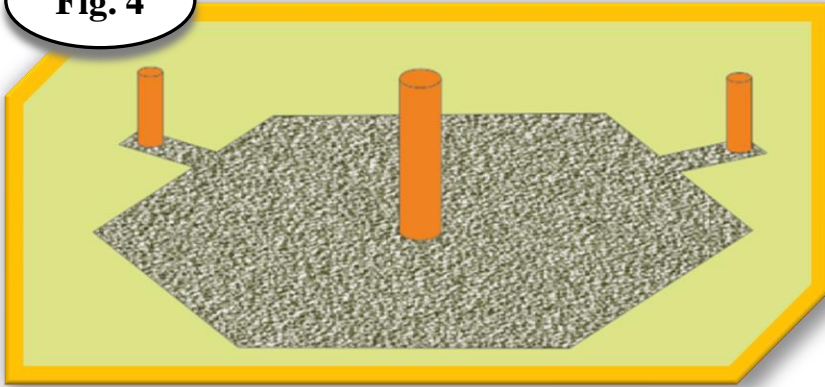

fig.4

Fill the pit with (0-5 granulation) gravel. The gravel should be level with the surface once the gravel has been compacted.

fig.5

Now build the wooden framework. (About 6in (15cm) high) Support these from the outside so that it doesn't break apart. **Measure the diagonals.** Place a pipe approx. 6in (15cm) away from the edge of the framework for potential electrical power supply.

Fig. 5

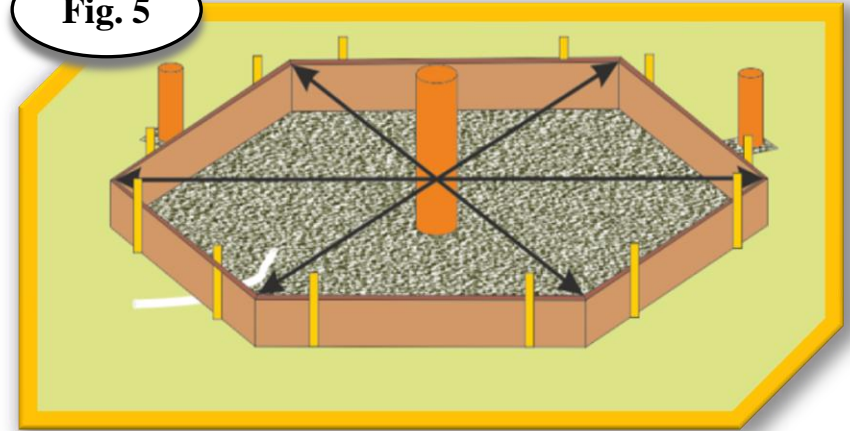
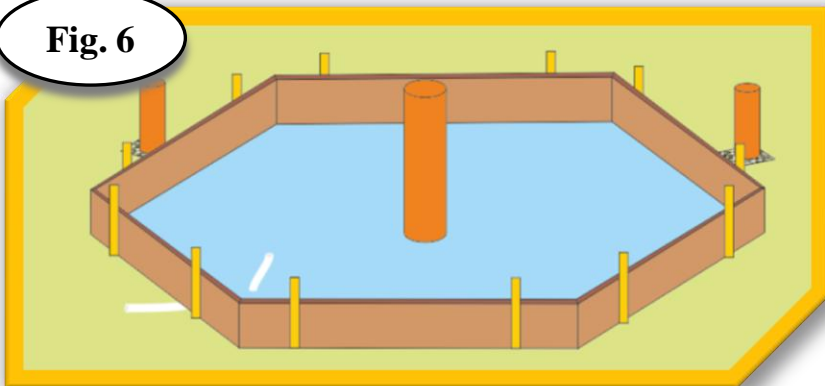

fig.6

Lay builders film (polythylene) onto the gravel to prevent entrapped moisture in the concrete foundation.

Fig. 6



# Construction of a concrete foundation

Fig. 7

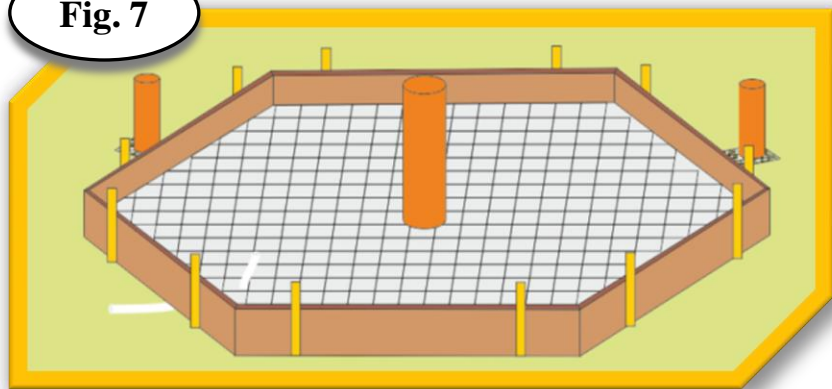

fig.7

Cut out a reinforcement mat (Q131) to size. Fill the pit half way with concrete (C 25/30) and place the reinforcement mat within.

fig.8

Now fill up the frame up to the edge with concrete. Compact and level out the concrete surface.

Fig. 8

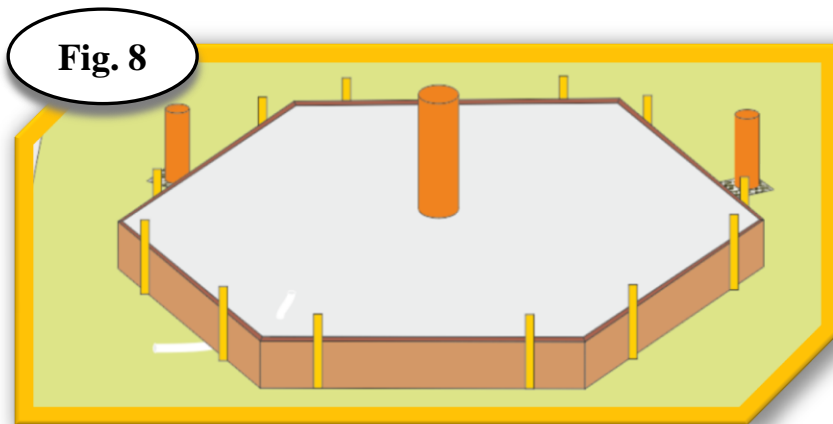
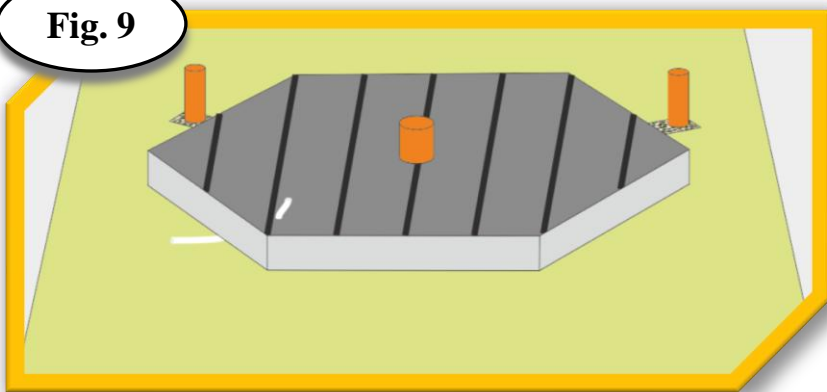

fig.9

After approx. seven days the concrete should be solid enough for further construction. (Depending on weather conditions). Cover the foundation with either tarpaper or put down builders film during assembly.

Fig. 9



**Minor high differences may be corrected during construction, however major differences may affect the stability of the Kota which could invalidate the warranty.**

# Construction of a foundation using paving stones

Fig. 10

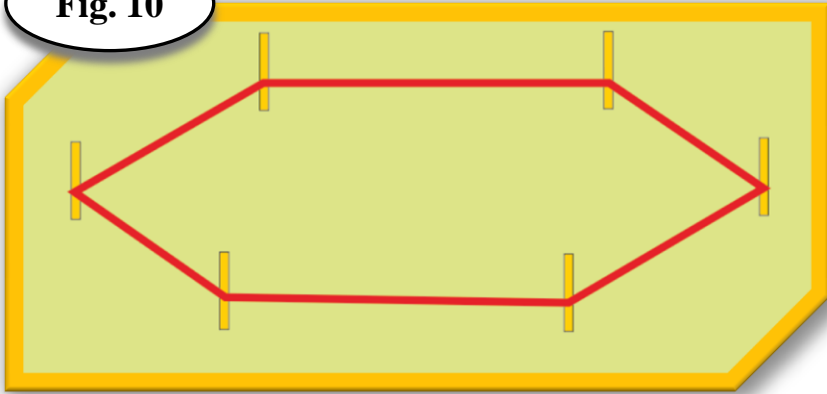

fig.10

Stake out the areal of where the foundation shall be placed.

fig.11

Dig up around 12-16in (30-40cm) of soil, depending on the soil structure.

Fig. 11

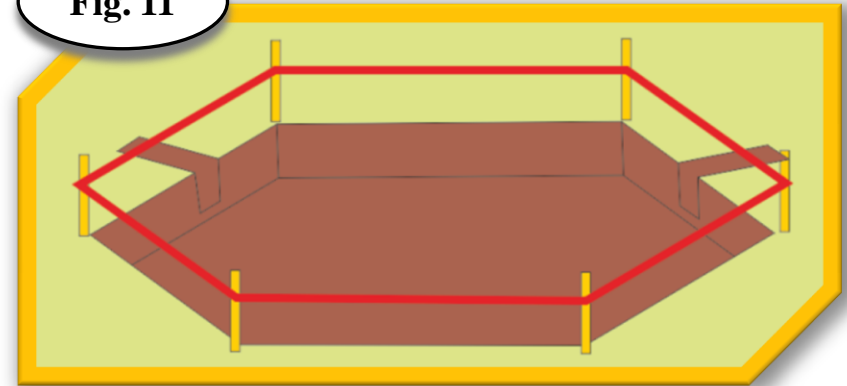
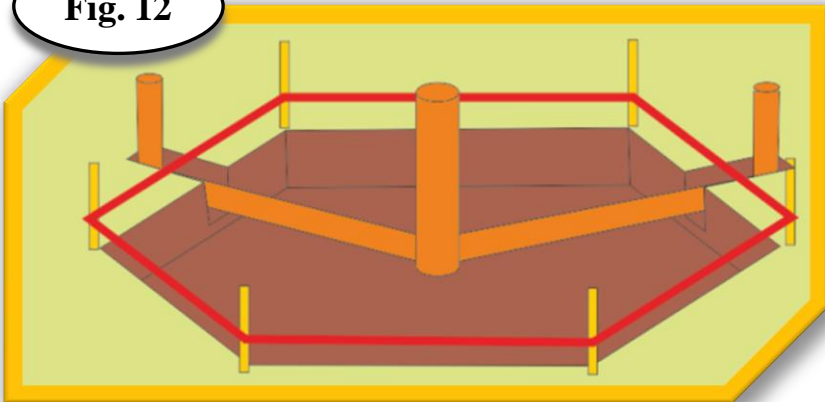

fig.12

Place the tubes as specified on page one of the manual. (see fig.)

Fig. 12





# Construction of a foundation using paving stones

Fig. 13

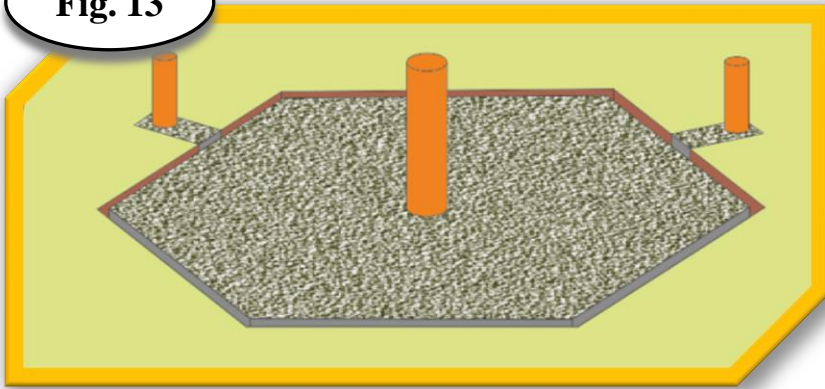

fig.13

Fill the pit with gravel (0-5mm granulation). Once the gravel has been compacted it should be level with the ground. Using a flat bladed shovel dig a groove of approx. 5in (12cm) depth for the edging stones.

fig.14

Set the 20cm edging stones into concrete making sure that they protrude 10cm out of the ground. **Measure the diagonals and check drying times.** Place a pipe approx. 6in (15cm) away from the edge of the framework for potential electrical power supply.

Fig. 14

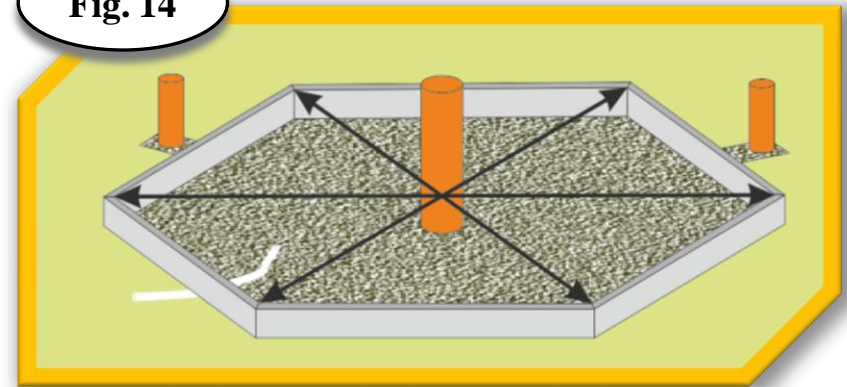



# Construction of a foundation using paving stones

Fig. 15

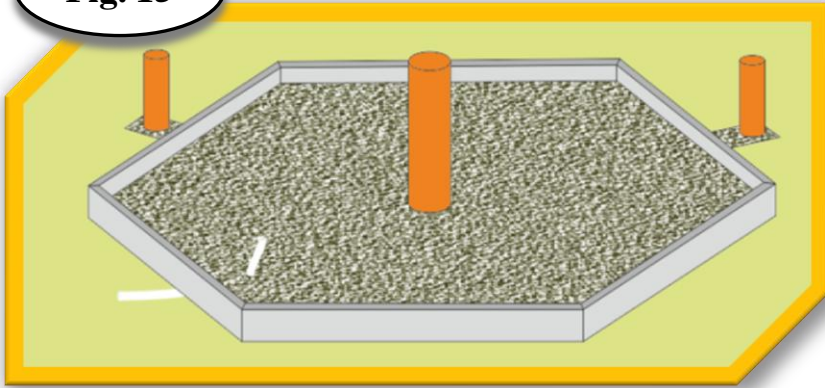

fig.15

Fill the area with rubble or smaller stones so that after compressing you still have 5cm to the upper edge of the edging stones. Even out the area.

fig.16

Lay out the area with 2.3in (6cm) thick paving stones. Compact the paving stones by using a vibration compactor 220-280lb (100-130kg) and a rubber plate. Do this until the paving is flush with the edging stones. Fill the gaps and joints with Sand.

Fig. 16

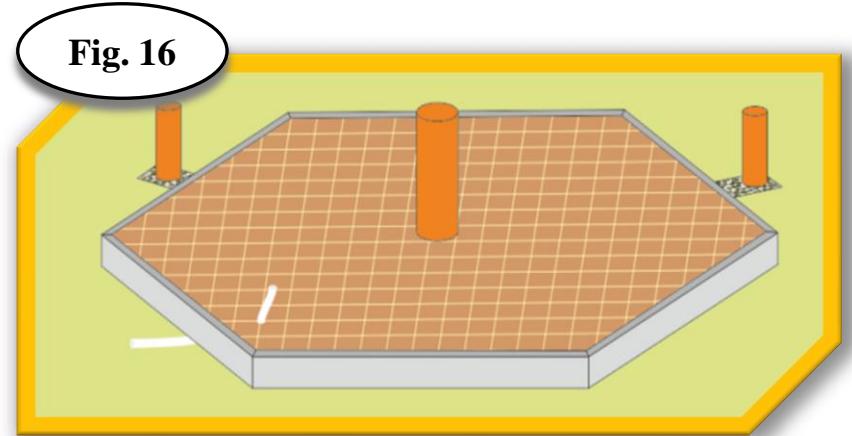

**Minor height differences may be corrected during construction, however major differences may affect the stability of the Kota which could invalidate the warranty.**

# Construction of a strip foundation

Fig. 17

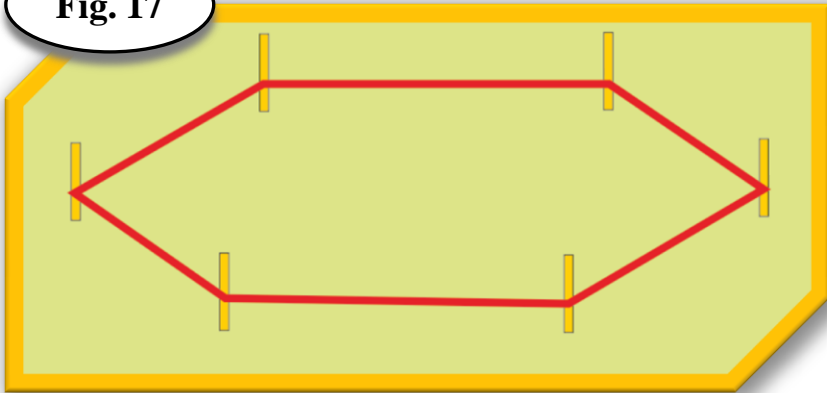

fig.17

Stake out the areal of where the foundation shall be placed.

fig.18

Dig out the outer frame approx. 31,5-35,5in (80-90cm). (approx. 12in (30cm) wide). In the area of the center struts approx. 12in (30cm). lay the pipes as shown in the foundation instructions.

Fig. 18

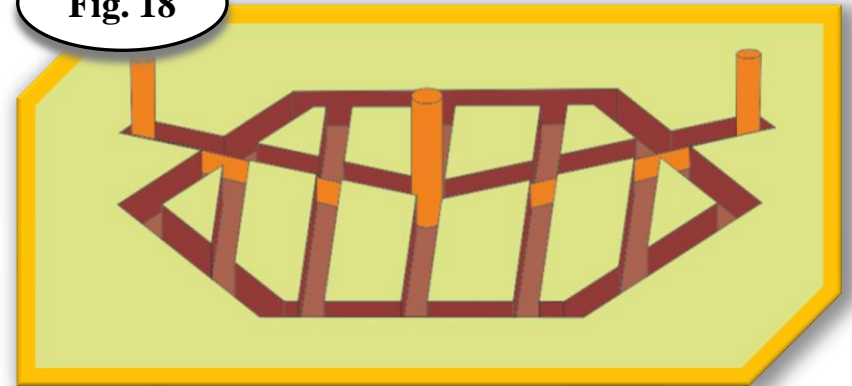

# Construction of a strip foundation

Fig. 19

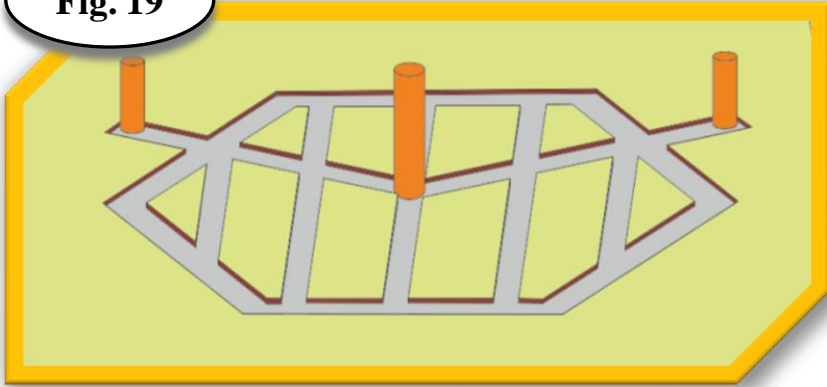

fig.19

Fill the excavations with earth-moist concrete (C25/30) leaving a 2in (5cm) gap to the edge of the surface. Put in 0,4in (10mm) reinforcing rods in various heights.

fig.20

Put the concrete blocks in the moist concrete so that they protrude 4in (10cm) above the ground. Make sure the surface is even. Place the enforcement rods into the blocks and fill these with concrete. The foundation should be ready for further construction within seven days. (Depending on weather conditions).

Fig. 20

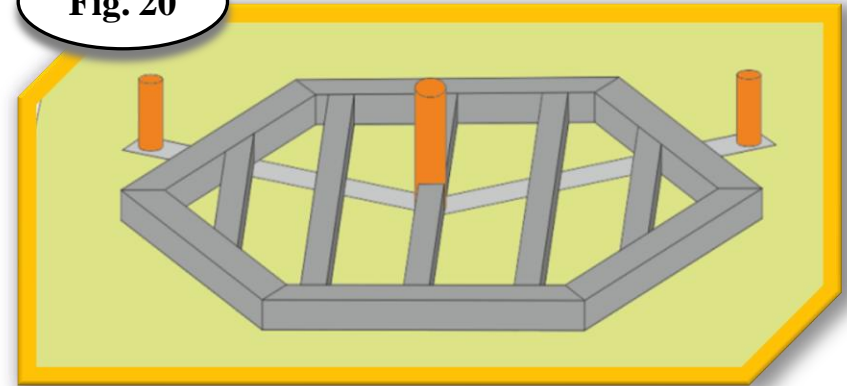

**Minor height differences may be corrected during construction, however major differences may affect the stability of the Kota which could invalidate the warranty.**