

www.juwel.com

JUWEL®

Clever products
for garden and home

Assembly instructions Cold frame Biostar 1500

Dim.: about 4.9 x 2.6 x H 1.6/1.3 ft
(150 x 80 x H 50/40 cm)

Art. no. 20150



Litho-Nr. 925-04-21 · Anl.-Nr. 04212328

JUWEL H. Wüster GmbH · A-6460 Imst, Industriezone 19, Tel. 0043-5412-69400
or D-82467 Garmisch-Partenkirchen, Bahnhofstr. 31, Tel. 0049-8821-1679
kund@juwel.com · www.juwel.com

USA Distributor: Exaco Trading · Customerservice@Exaco.com
877-760-8500 ext. 701 · 10203 Metropolitan Dr · Austin, TX 78758

Part list:

A	B	C*	D*	E*	F	G	H
1 x	1 x	1 x	1 x	3x	2x	2x	1x
52598	52599	52590	52589	52600	52398	52397	25933

I	J	K	L	M	N	O	P	Q
8x	8x	8 x	4x	4x	1x	1x	2 x	2 x
25939	26398	26399	26808	25607	20047	25940	52511	52780

* See step **1** before removing protective film

Required tools!



Please read these instructions prior to assembly and keep them for further reference.

Dear valued customer,

Please find below some advice on how to use your cold frame and increase your harvests.

This cold frame is made of double-wall polycarbonate glazing, as used in professional greenhouses. This special glazing lets sun rays go through and keeps warmth inside, which is essential for the growth of plants.

However, too hot temperatures can be harmful for plants! That's why we advise you to open or remove the sliding windows of the window when sun rays are particularly intensive. When it's colder (below 10°C/50°F), close the windows to keep warmth inside the cold frame.

Despite its excellent insulation, the cold frame still needs sunlight when it's cold outside. If you are experiencing several days without sunlight and very cold temperatures, you may need a complementary

heat source (e.g. heat lamp) to keep the cold frame from freezing.

The morning is the best time to water your plants, which should be dry again by the evening, when it gets colder. Thus, the plants do not cool off so much and the risk of fungal infection is reduced.

Please choose seeds suitable for greenhouse culture.

The ground stakes should be hammered slantwise, so that the cold frame is well stabilised. By strong wind, it may be necessary to use an additional fixing system. If it's likely to be windy, close the window and lock the window handle securely to keep the window from flying away.

CAUTION: This product is intended for private use and not for commercial purposes.

At last, we wish you plentiful harvests!



Warning: Strong wind or storm can fly the cold frame away and injure people or cause material damage.

GENERAL POINTS

Symbol legend

The following symbols and signal words are used in these directions for use, on the cold frame or on the packaging.



WARNING! This signal word draws attention to the risk of a medium-degree danger which if not avoided can lead to a fatal or serious injury.



CAUTION! This signal word draws attention to the risk of low-degree danger which if not avoided can lead to a minor or moderate injury.



NOTE! This signal word warns against the possibility of damage to property or provides useful additional information on assembly or on operation.

Check the cold frame and the content



NOTE! Risk of damage!
The cold frame can be easily damaged if the packaging is opened carelessly with a sharp knife or other pointed object. Be very careful when opening it therefore.

1. Check if the content is complete.
2. Take the cold frame out of the packaging and check if the cold frame or the individual parts are damaged. If they are, do not use the cold frame. Contact the manufacturer at the given service address.

Read and keep the directions



These directions form a constituent part of the content of the cold frame. They contain important information on assembly and handling. Read the directions carefully, in particular the safety instructions, before using the cold frame. Non-compliance with these instructions can lead to injuries or damage to the cold frame.

The directions are based on the standards and rules which apply in the European Union. In other countries, please observe the country-specific directives and laws.

Keep the instructions for further use. If you pass on the cold frame to a third party, it is essential to give these instructions with it.

SAFETY

Use for the intended purpose

The cold frame has been designed exclusively for the purpose of growing plants. It is exclusively intended for private use and is not suitable for the commercial sector.

Use the cold frame only in the manner described in these directions. Any other use is not considered to be in accordance with the intended purpose and can lead to damage to property or even to personal injury. The manufacturer or dealer will not accept any liability for damage caused by incorrect use or use that is not in accordance with the intended purpose.

Safety instructions



WARNING!
Danger of suffocation! Children playing with the packaging film can get caught in it and suffocate.

- Do not let your children play with the packaging foil.



WARNING!
Risk of injury! If there is a strong wind, the lid can fall on your fingers or the cold frame can be torn away and this can cause damage to property or personal injury.

- Set up the cold frame in a place where it will be sheltered from the wind.
 - Close the lid when there is a strong wind or storm.
- Hook the vent opener into the front wall, so that the lid cannot be opened again.
- The lid may only be opened and fixed in place when there is no wind.
 - Additional security may be required in wind prone areas.



ASSEMBLY



CAUTION!
Risk of damage! The walls and the lid of the cold frame are breakable and can be damaged or destroyed if you do not assemble the cold frame with the necessary care.

- Assemble the cold frame carefully and on a suitable base.
- 1-2 people should assemble the item. We recommend you to wear protective gloves during assembly.

USE



NOTE!
Risk of damage! Handling the cold frame or your plants incorrectly can cause the plants to die or mould spores to form in it.

- Open and fix the lid in position during strong sunlight. Close the lid again when it becomes cooler (drop in temperature to less than 10 °C).
- Use a source of heat, e.g. a heat lamp, when outside temperatures are low or when there are several days with only little sunlight.
- Water the plants in the morning.
- Take care that the seeds you wish to plant are suitable for greenhouses and cold frames. The highly heat-insulating hollow-chamber plates absorb the incident solar radiation and convert it into heat. The heat helps your plants grow better.
- In the summer when temperatures don't drop below 15 °C even at night time, you can take the lid off completely or simply disassemble the cold frame and put it away in a protected place until it is next used.
- When inserting the ground anchors that are included in the content into the ground, insert them as diagonally as possible so that the cold frame will be anchored securely. Close the lid if there is a strong wind or storm. Hook in the vent opener on the front wall so that the lid cannot be opened again.

CLEANING



CAUTION!
Risk of damage! Handling the cold frame incorrectly can cause damage.

- Do not use any aggressive detergents, brushes with metal or nylon bristles or sharp, rough or metallic cleaning objects such as knives, hard scrapers or suchlike. These can damage the surfaces.
- Use a garden hose or a watering can to wash down the cold frame.
- Use a soft cloth to remove dirt.

STORAGE

- Make sure that all cold-frame components are completely dry.
- Keep the cold frame in a dry place that is sheltered from the wind.
- Store the cold frame out of reach of children, closed securely and at a storage temperature between + 5° C and + 20° C (room temperature).

TECHNICAL DATA

Weight: 24.67 lb | 11,28 kg
Dimensions: ~ 4.9 x 2.6 x H 1.6/1.3 ft
Article number: 20150

WASTE DISPOSAL

Disposal of packaging / cold frame



Dispose of the cold frame / packaging in accordance with the rules and regulations that apply in your country.

1

ATTENTION:
Take away
protection foil!

BLUE film
(UV resistant)
toward the
OUTSIDE!

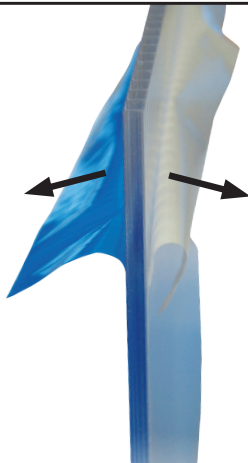

CLEAR film
toward the
INSIDE!

C-1 x D-1 x

2

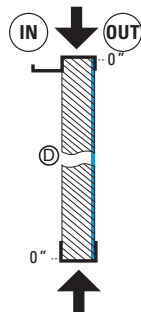
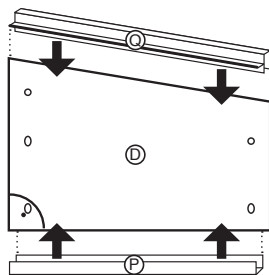
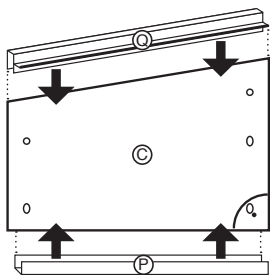
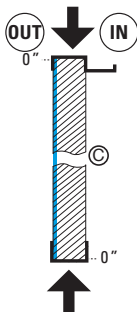

C-1 x D-1 x P-2 x Q-2 x

3

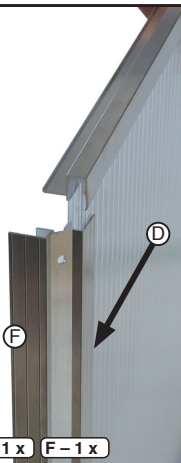

D-1 x F-1 x

4

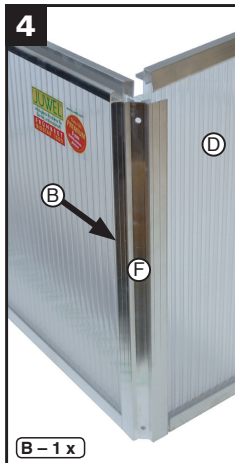

B-1 x

5a

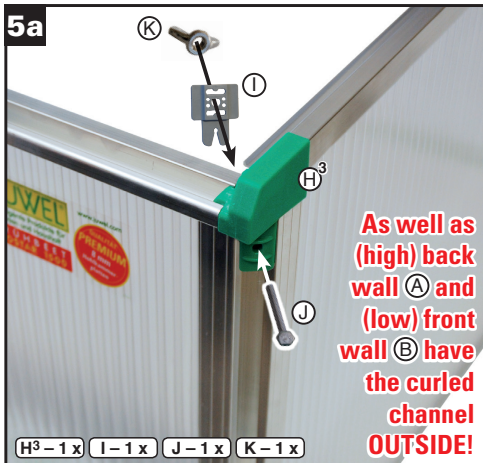

H³-1 x I-1 x J-1 x K-1 x

As well as
(high) back
wall (A)
and
(low) front
wall (B)
have the
curled
channel
OUTSIDE!

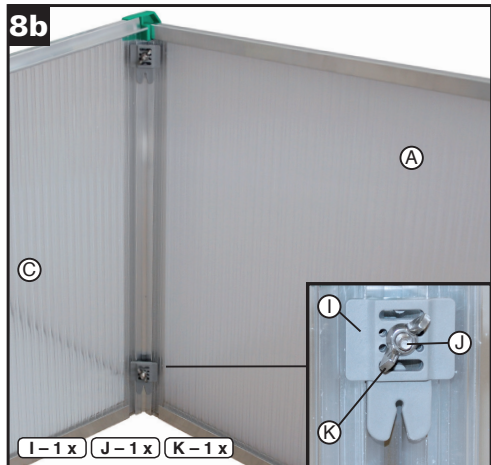
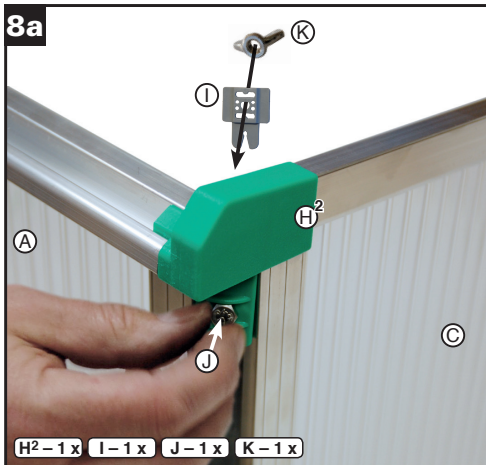
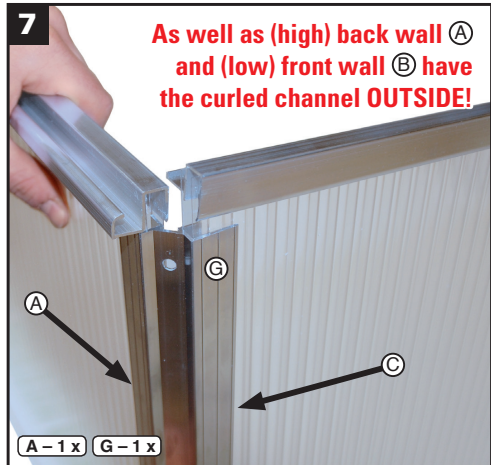
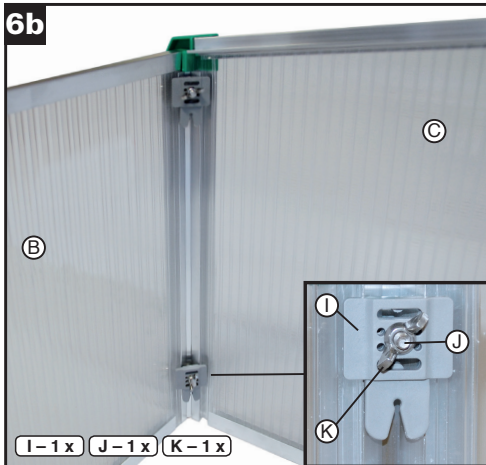
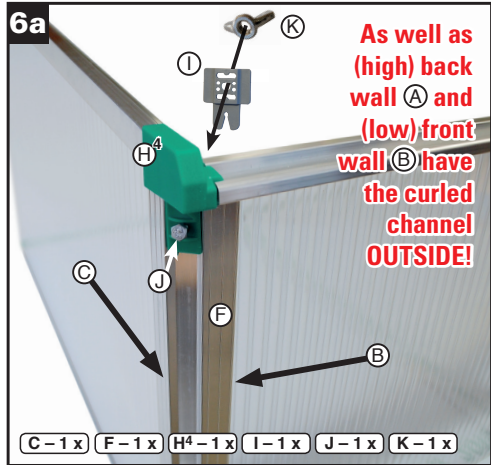
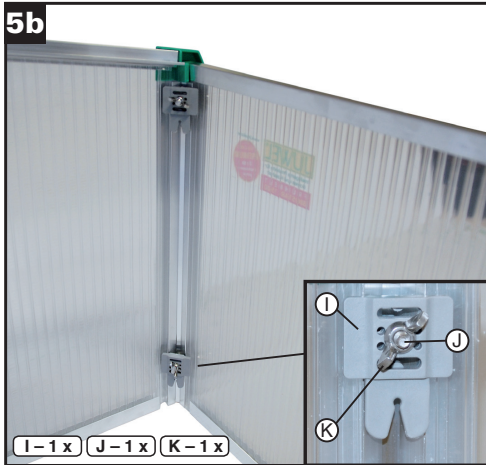

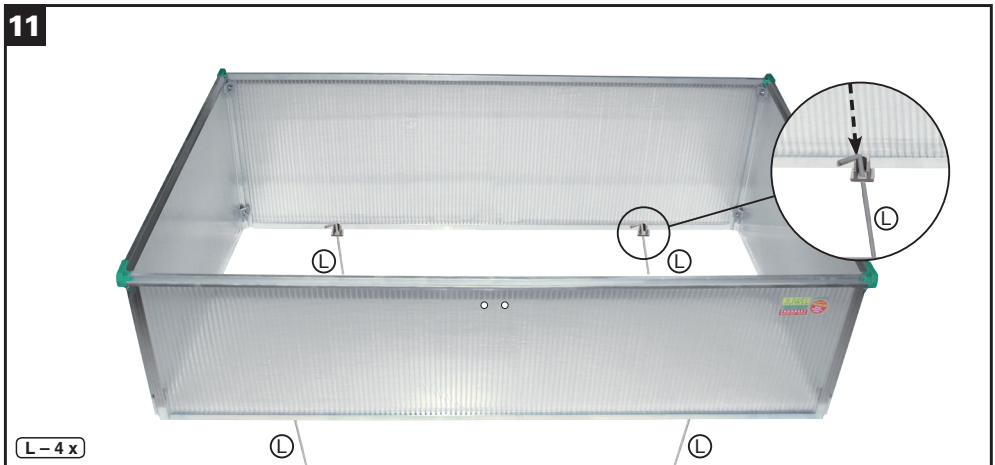
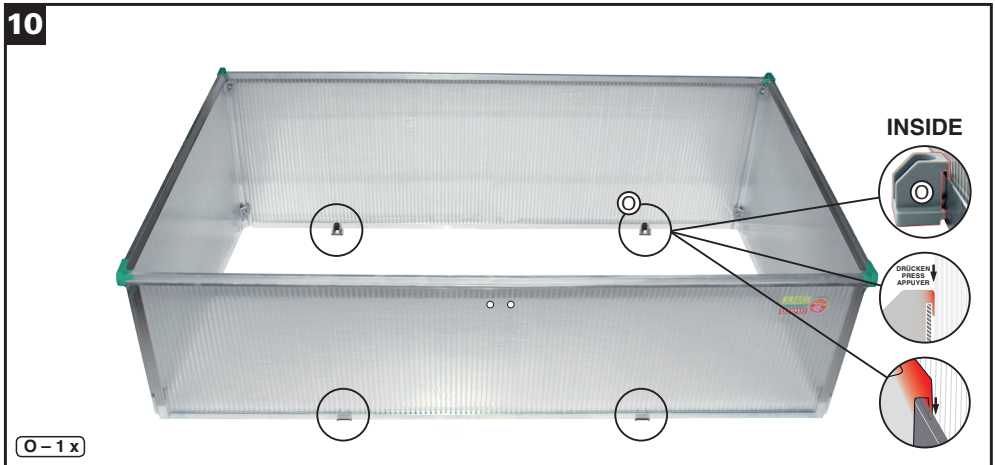
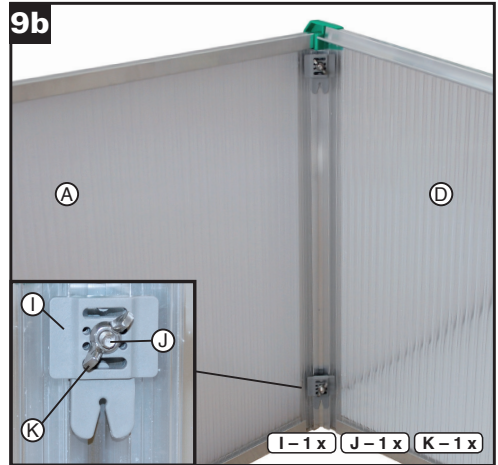
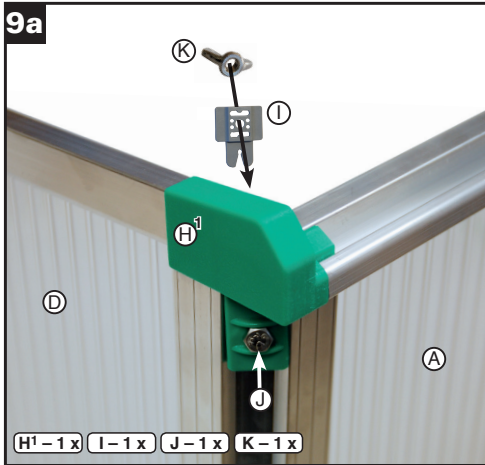

12

Insert vertically

Note that Lip/channel of back wall is on the OUTSIDE of the coldframe (same positioning for front wall) this is what creates the hinge

E - 3 x



13

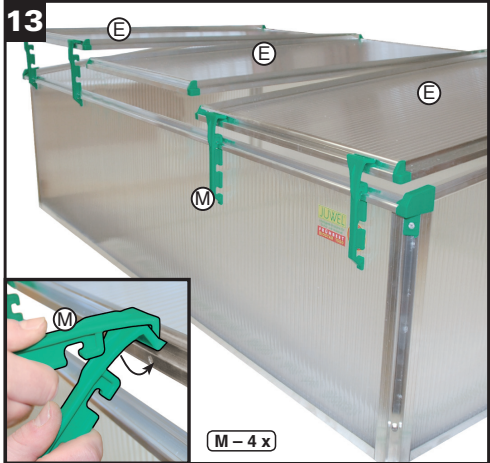

M - 4 x

14



Attention: Do not use the windproof catches (M), together with the automatic window opener (N)!

15



N - 1 x

Assembly instructions for the Window Opener — next page!

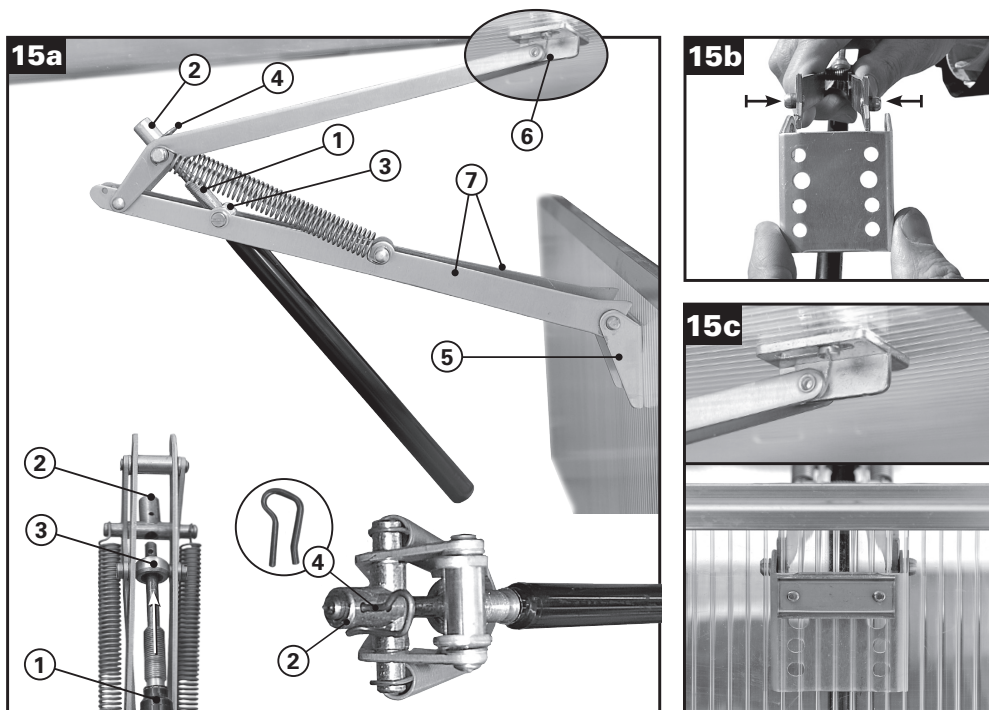

Automatic window opener for JUWEL cold frames and greenhouses (Art. no. 20047)

Components:

- A) Cylinder
- B) Lever assembly with two springs
- C) Hardware kit

The cylinder contains a liquid expanding contracting in consequence of the temperature and thus moving the piston rod.

ATTENTION: The inside of the cylinder is under pressure – **do not block the opening of the piston rod, do not try to open the cylinder and do not expose the opener to heat. Maximum opening weight 15 lb | 7 kg! Do not block the window or put weight on it – loss of guarantee.**

Warranty: A correctly fitted and used opener is guaranteed one full year, based on date of purchase as per dealer's receipt.

Maintenance: All moving parts should be lubricated from time to time by smearing the cylinder threads and piston shaft with a little vaseline.

Installation: As per **fig. 15a** take the cylinder and insert the piston rod (1) through the threaded cylinder housing (3) into the receptacle in part (2). Screw the

cylinder into the cylinder housing (3), adjust the hole of the piston rod to the first borehole of the receptacle in part (2) and secure with the smaller of the 2 pins (4).

Remove the frame bracket (5) by squeezing the forks together (**fig. 15b**) and mount it from inside on the panel of the frame, 1.6" | 40 mm below the aluminium edging on top of the panel, near to the mid-point of one of the top covers. The swivelling cover bracket (6) has to be mounted to the underside of the cold frame top cover with a distance of 2" | 50 mm from the edge and near the mid-point (**fig. 15c**). Now attach the bottom of the opener to the lower bracket by squeezing the lower forks (7) together. Make sure the top cover does not stick and can be easily moved.

Adjustment: Turn the cylinder **CLOCKWISE** for the opener to begin opening at a lower temperature, turn the cylinder **COUNTER-clockwise** for it to begin opening at a higher temperature and result in a narrower full-opening. Each full turn accounts for about 0,9°F | 0,5°C.

Attention: Do not use the windproof catches (M), together with the automatic window opener (N)!