

<b>ASSEMBLY INSTRUCTIONS</b>
PROJECT : ANDREW
LOCATION : USA

drawing title                      date 18/10/2018                      scale NTS

**STEP 1**



53x Jl.Uluwatu 2, Jimbaran-Bali-Indonesia  
 Phone/fax: +62 361 8472 101  
 info@pt-touchwood.com  
 www.pt-touchwood.com

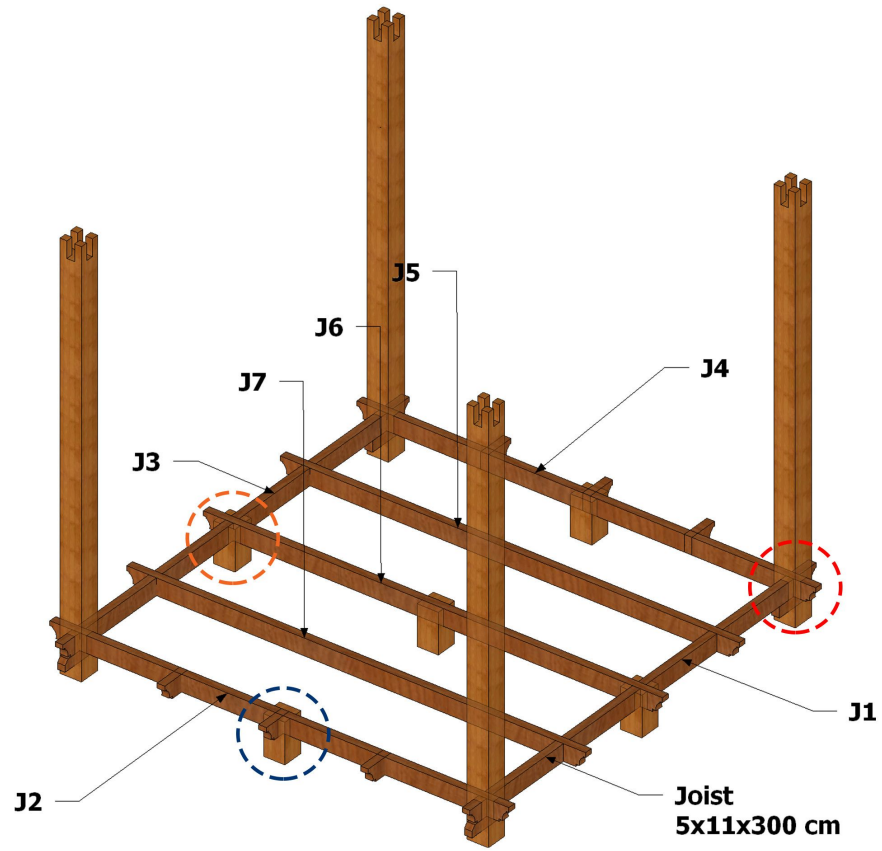

<b>ASSEMBLY INSTRUCTIONS</b>
PROJECT : ANDREW
LOCATION : USA

drawing title      date 18/10/2018      scale NTS

**STEP 2**

53x Jl.Uluwatu 2, Jimbaran-Bali-Indonesia  
 Phone/fax: +62 361 8472 101  
 info@pt-touchwood.com  
 www.pt-touchwood.com

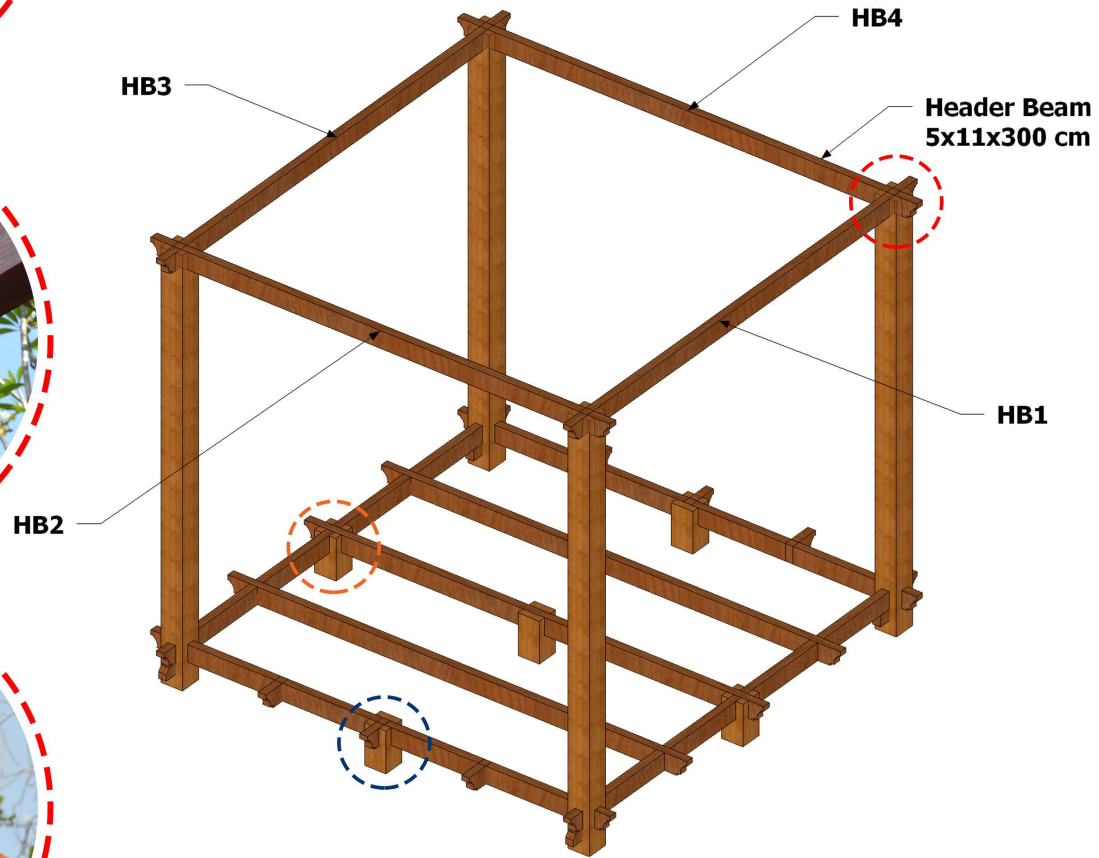

<b>ASSEMBLY INSTRUCTIONS</b>
PROJECT : ANDREW
LOCATION : USA

drawing title      date 18/10/2018      scale NTS

**STEP 3**



53x Jl.Uluwatu 2, Jimbaran-Bali-Indonesia  
Phone/fax: +62 361 8472 101  
info@pt-touchwood.com  
www.pt-touchwood.com

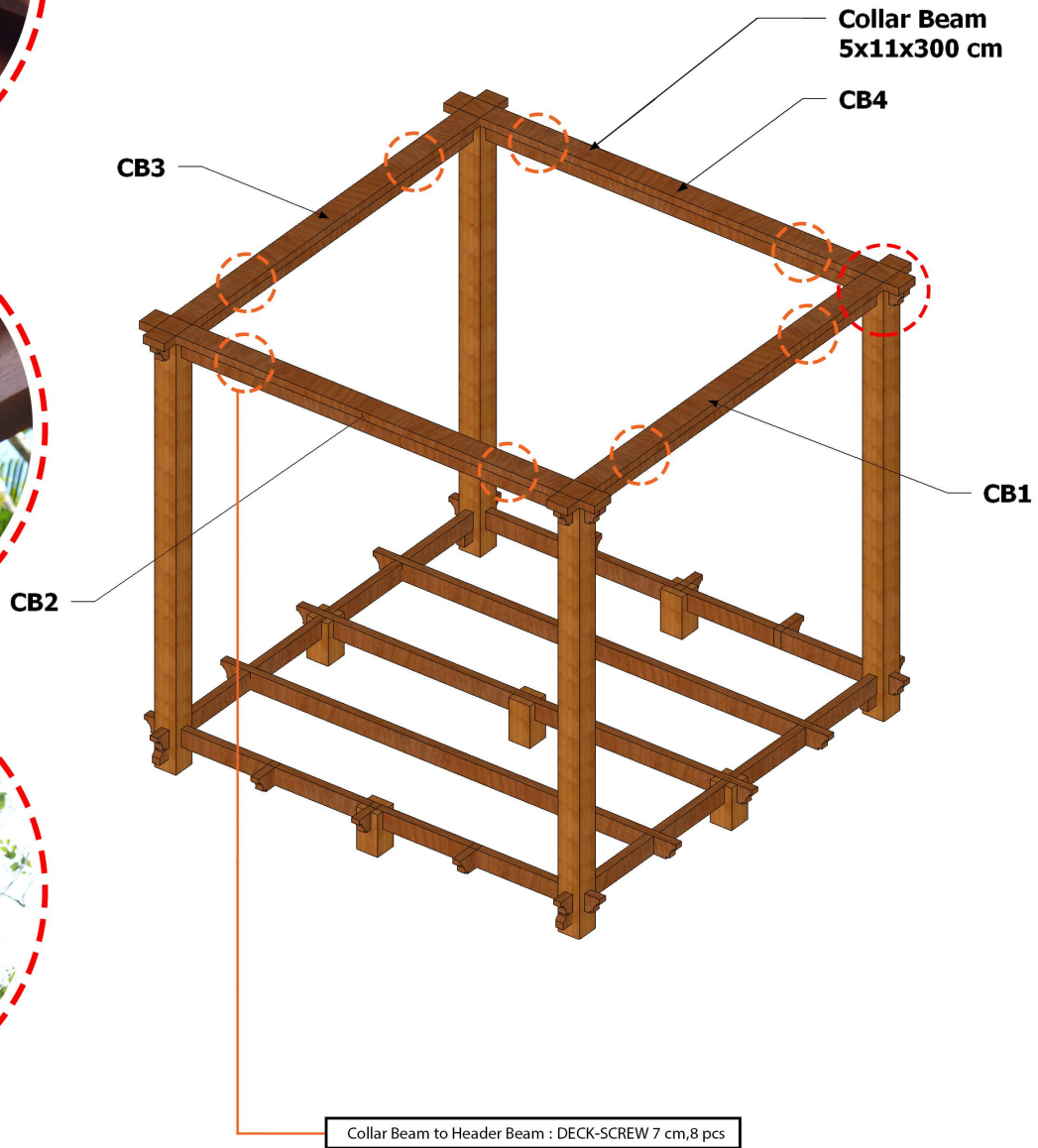

<b>ASSEMBLY INSTRUCTIONS</b>
PROJECT : ANDREW
LOCATION : USA

drawing title                      date 18/10/2018                      scale NTS

**STEP 4**



53x Jl.Uluwatu 2, Jimbaran-Bali-Indonesia  
 Phone/fax: +62 361 8472 101  
 info@pt-touchwood.com  
 www.pt-touchwood.com

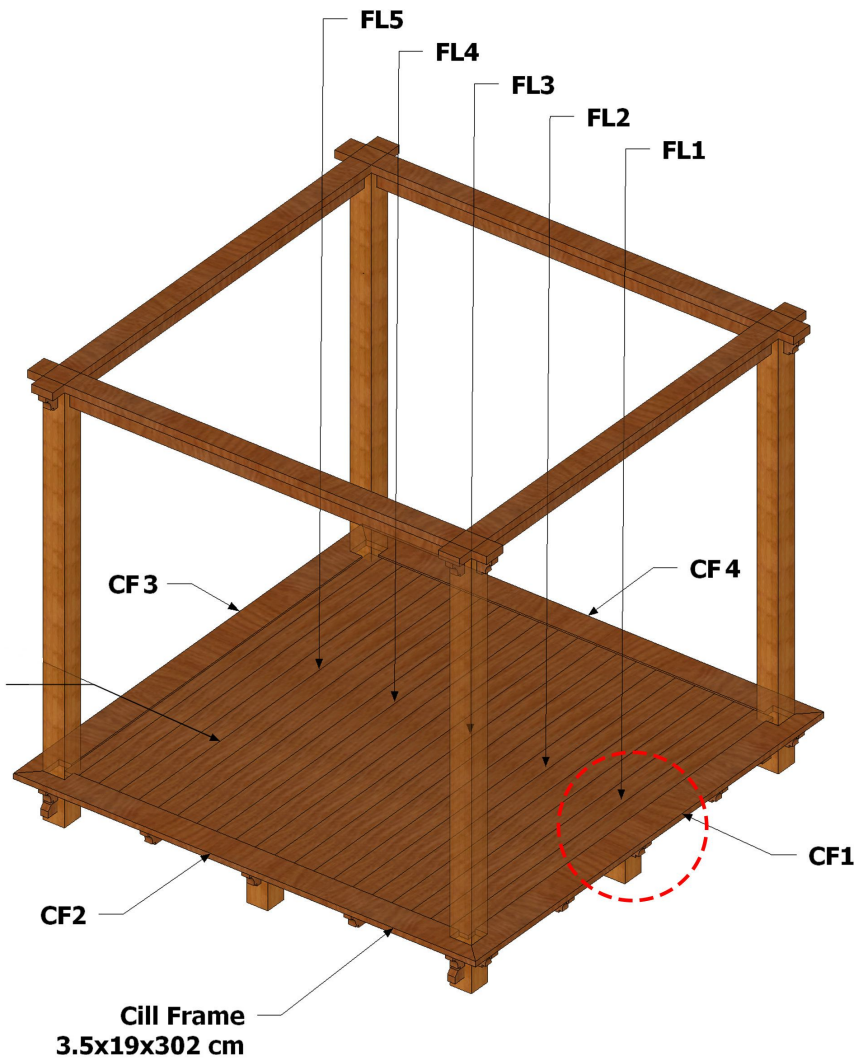
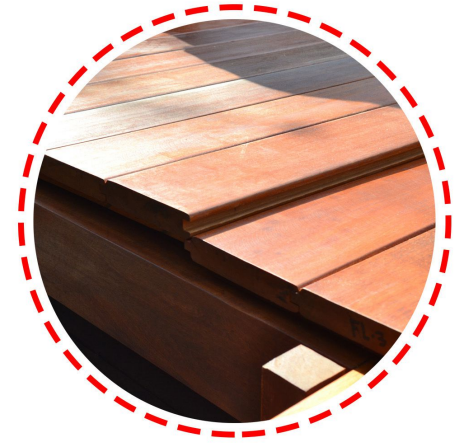

Flooring T&G  
2.5 x 265 cm

<b>ASSEMBLY INSTRUCTIONS</b>
PROJECT : ANDREW
LOCATION : USA

drawing title      date 18/10/2018      scale NTS

**STEP 5**



53x Jl.Uluwatu 2, Jimbaran-Bali-Indonesia  
Phone/fax: +62 361 8472 101  
info@pt-touchwood.com  
www.pt-touchwood.com

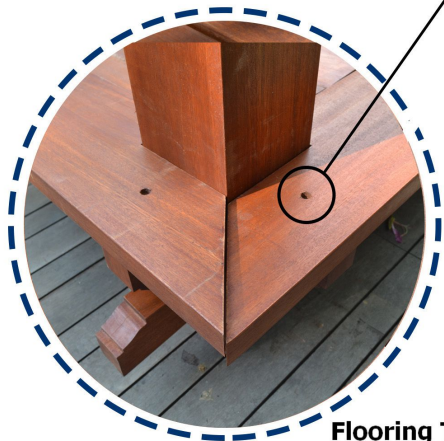
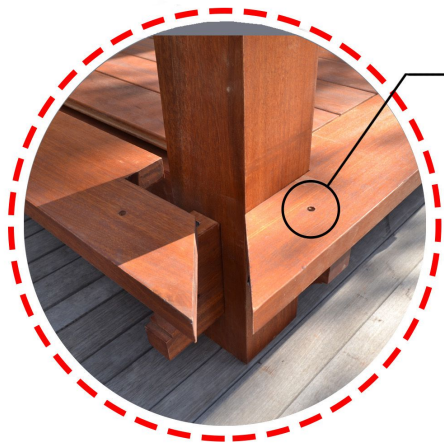

Cill Frame to Joist : SCREW 7 cm,12 pcs

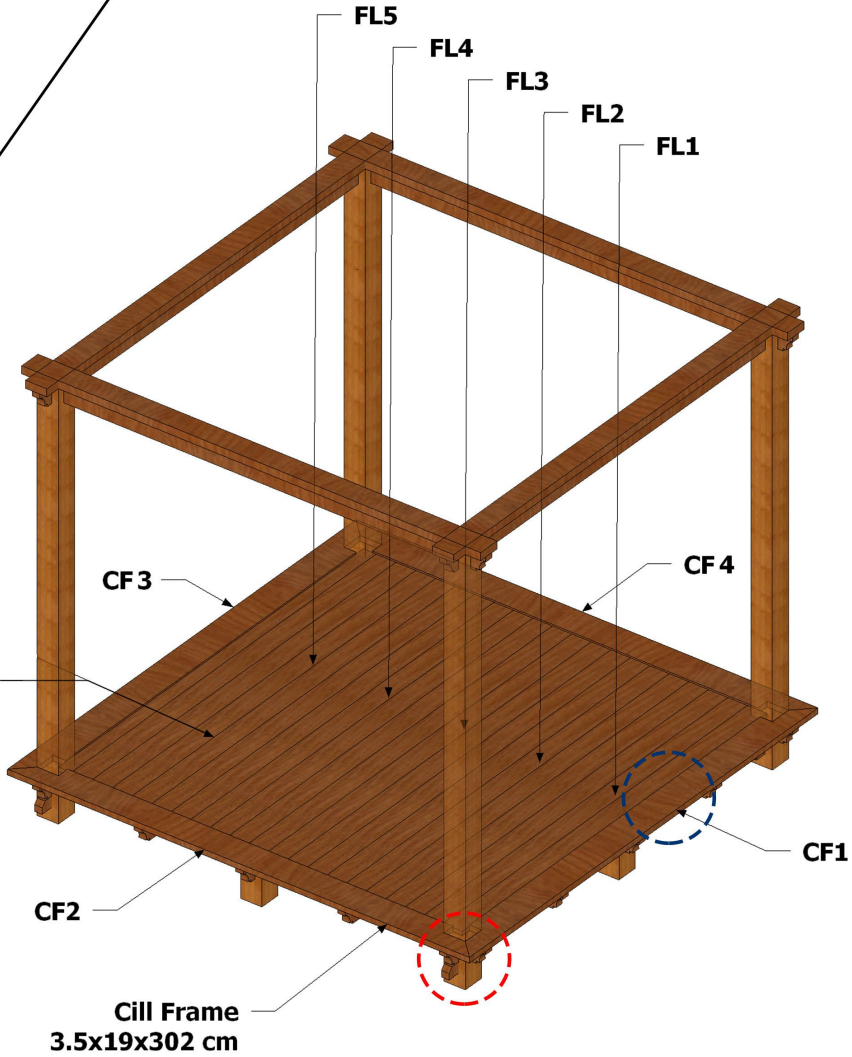

Flooring T&G  
2.5 x 265 cm

Cill Frame  
3.5x19x302 cm

<b>ASSEMBLY INSTRUCTIONS</b>
PROJECT : ANDREW
LOCATION : USA

drawing title      date 18/10/2018      scale NTS

**STEP 5**

53x Jl.Uluwatu 2, Jimbaran-Bali-Indonesia  
 Phone/fax: +62 361 8472 101  
 info@pt-touchwood.com  
 www.pt-touchwood.com

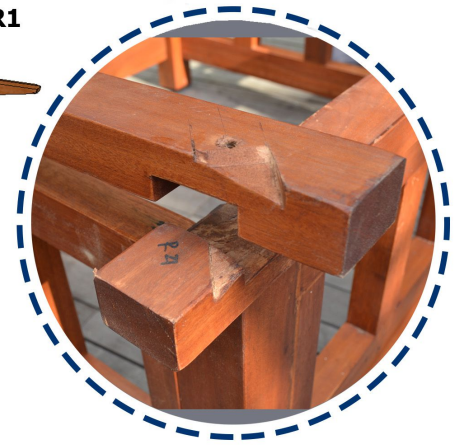
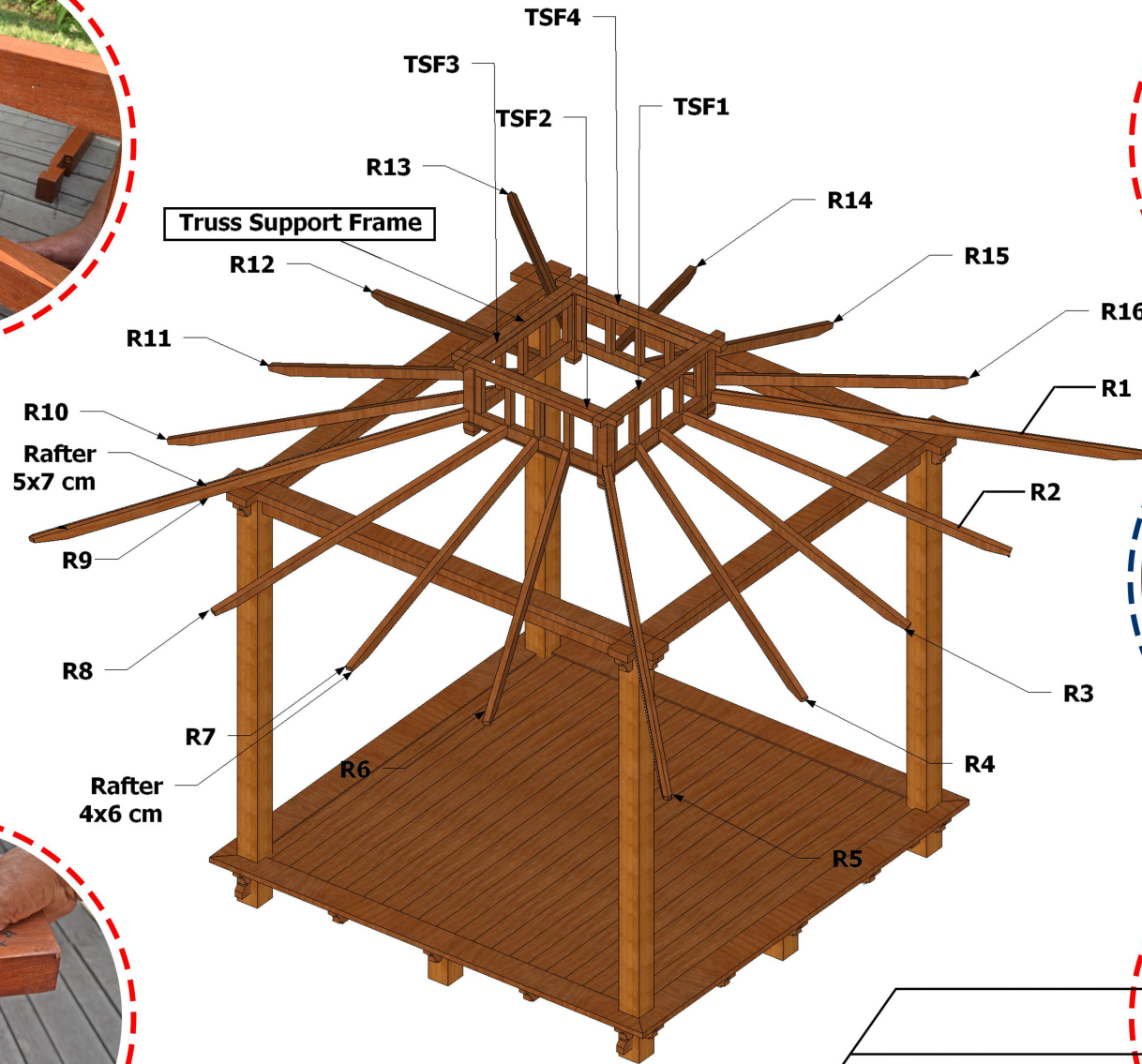

Truss Support Frame : DECK-SCREW 7 cm, 12 pcs

<b>ASSEMBLY INSTRUCTIONS</b>
PROJECT : ANDREW
LOCATION : USA

drawing title	date 18/10/2018	scale NTS
<b>STEP 6</b>		

53x Jl.Uluwatu 2, Jimbaran-Bali-Indonesia  
Phone/fax: +62 361 8472 101  
info@pt-touchwood.com  
www.pt-touchwood.com

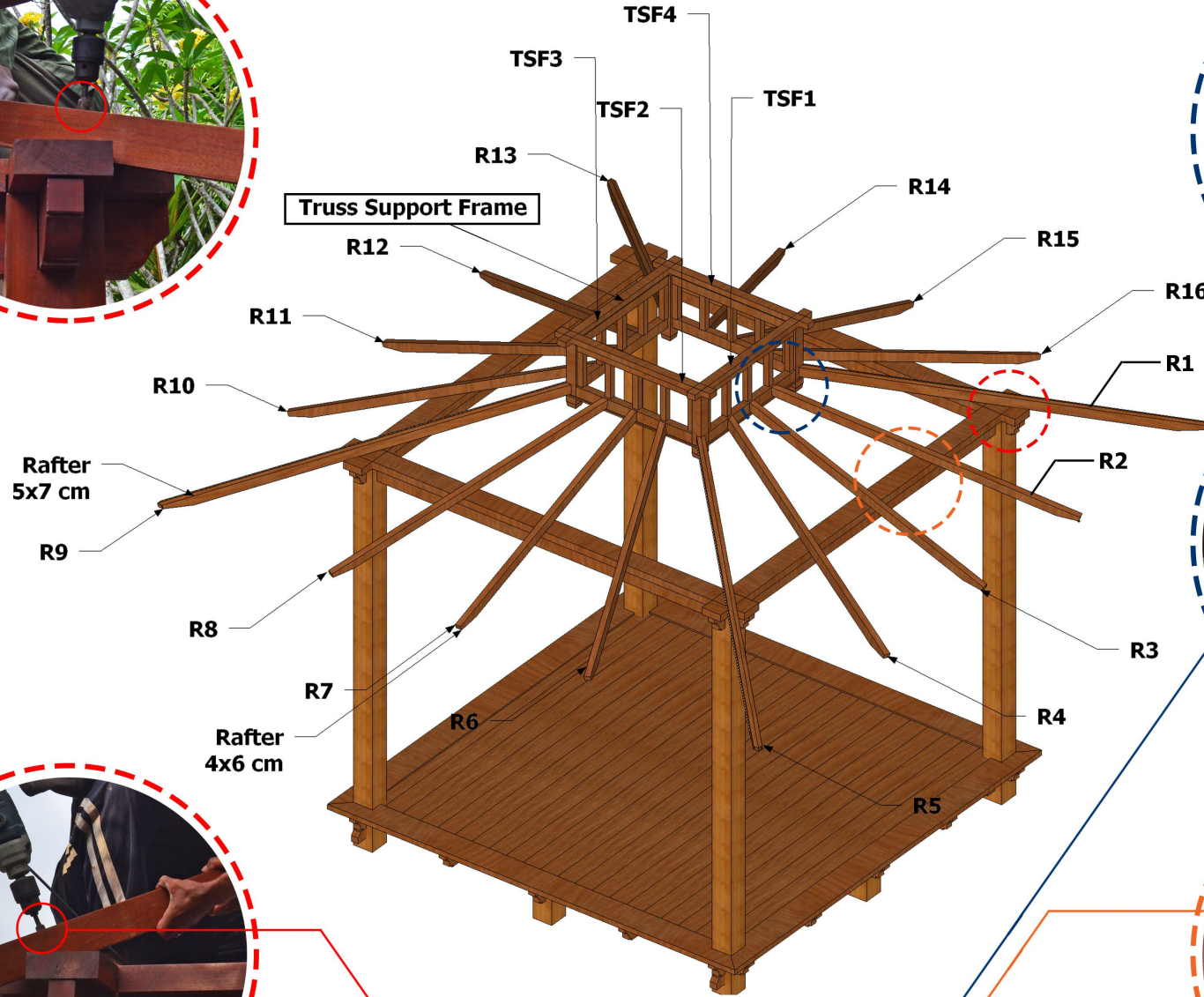
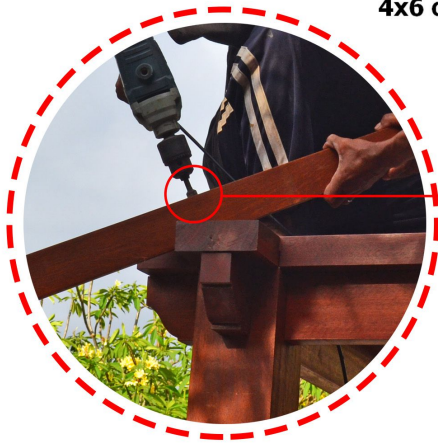
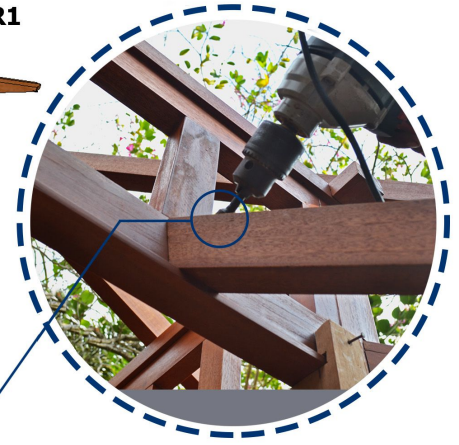

- Rafter to Truss Support Frame : DECK-SCREW 5 cm,16 pcs
- Rafter to Collar Beam : DECK-SCREW 7 cm,12 pcs
- Rafter HIP to Collar Beam : DECK-SCREW10 cm,4 pcs

**ASSEMBLY INSTRUCTIONS**  
 PROJECT : ANDREW  
 LOCATION : USA

drawing title      date 18/10/2018      scale NTS  
**STEP 6**

53x Jl.Uluwatu 2, Jimbaran-Bali-Indonesia  
 Phone/fax: +62 361 8472 101  
 info@pt-touchwood.com  
 www.pt-touchwood.com



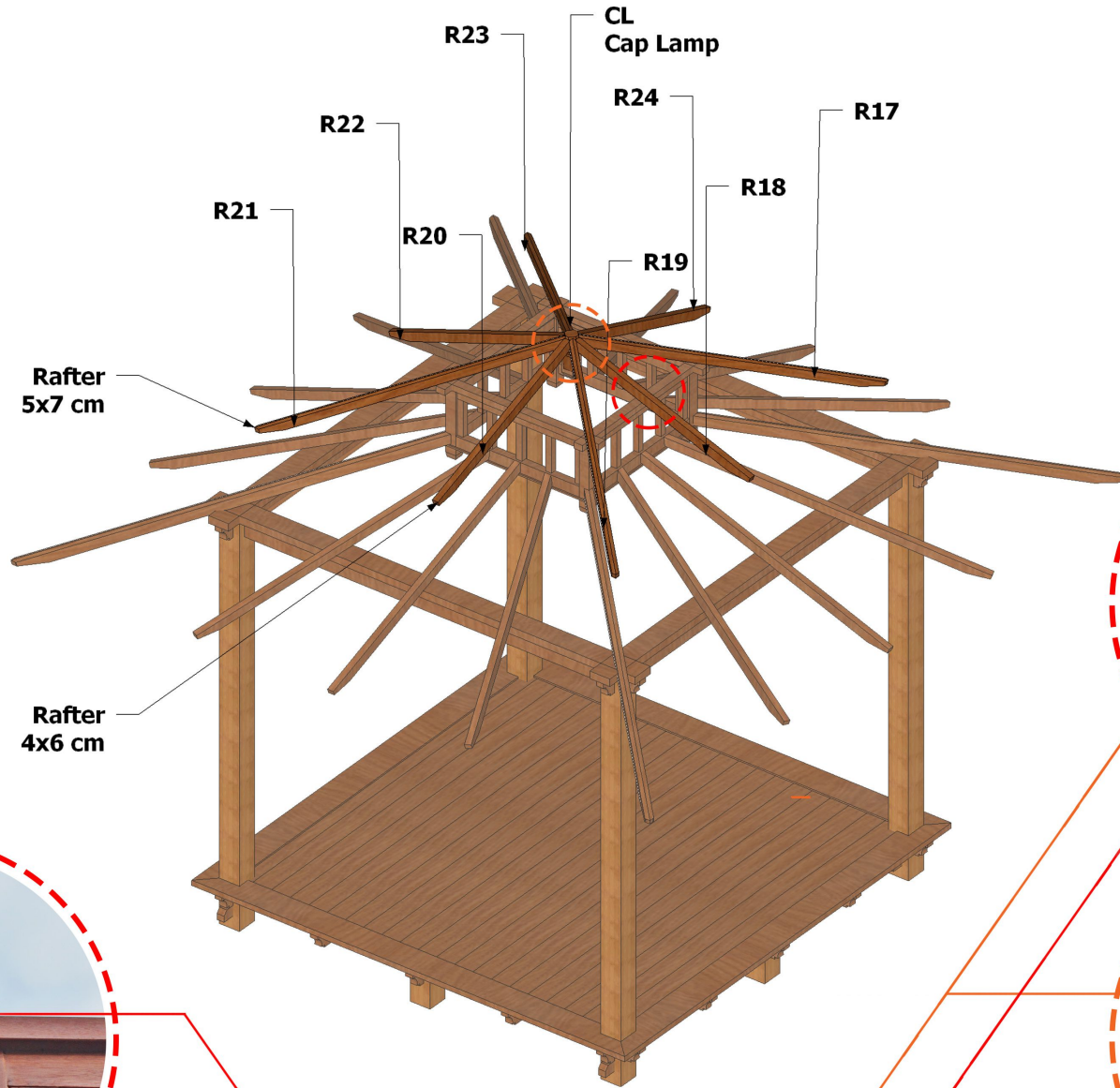

Rafter to Cap Lamp : DECK-SCREW 5 cm,8 pcs  
 Rafter to Truss Support Frame : DECK-SCREW 7 cm,8 pcs

**ASSEMBLY INSTRUCTIONS**  
 PROJECT : ANDREW  
 LOCATION : USA

drawing title      date 18/10/2018      scale NTS  
**STEP 7**

 53x Jl.Uluwatu 2, Jimbaran-Bali-Indonesia  
 Phone/fax: +62 361 8472 101  
 info@pt-touchwood.com  
 www.pt-touchwood.com

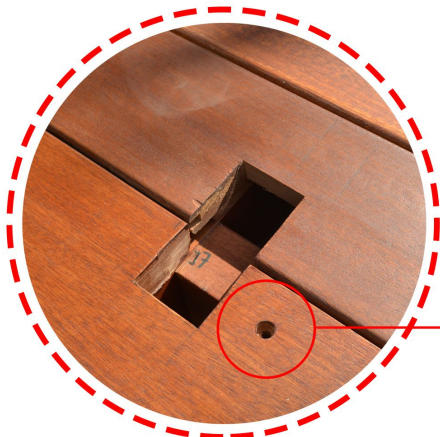
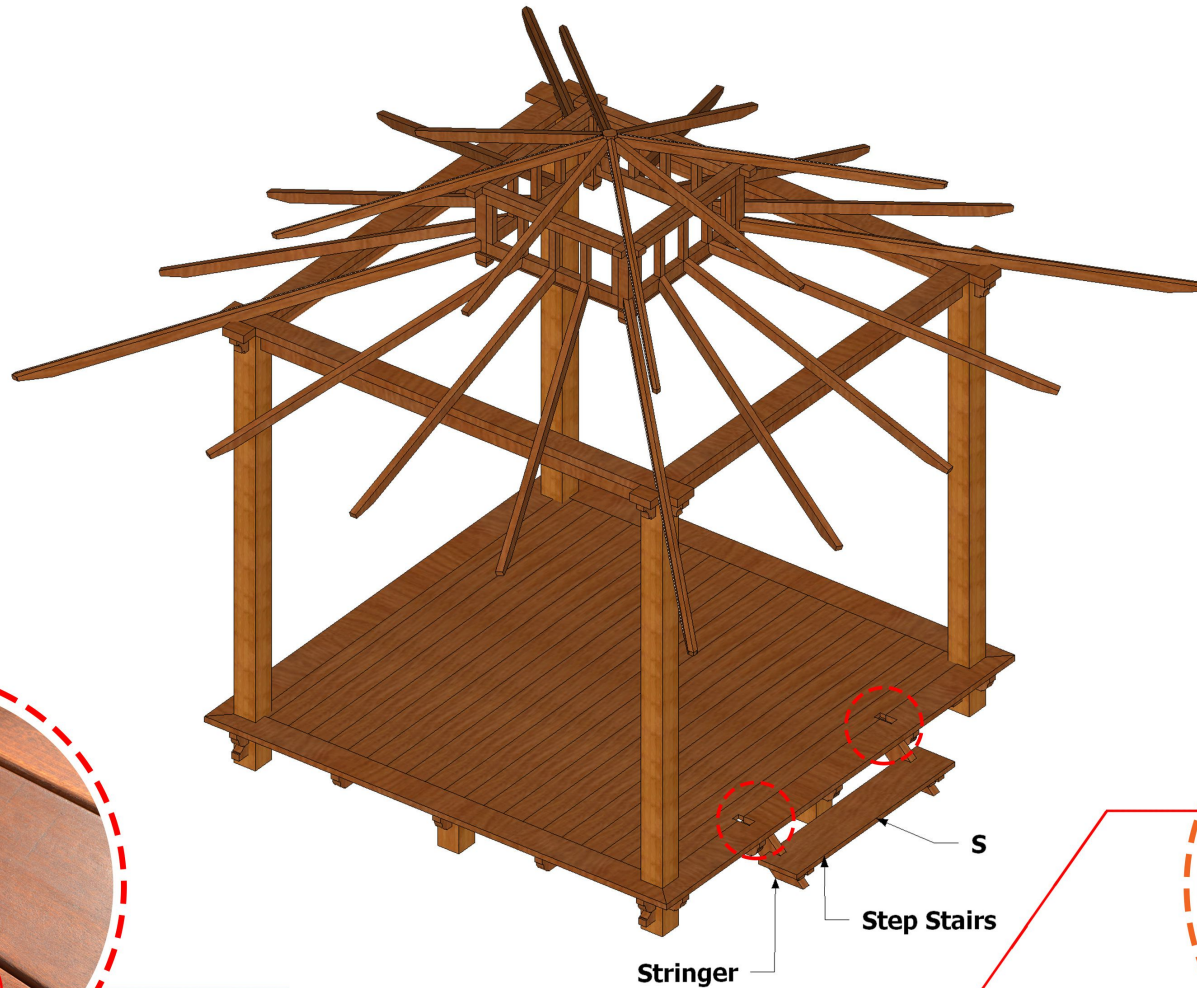

Cill Frame to Stringer Stairs : SCREW 7 cm,4 pcs

**ASSEMBLY INSTRUCTIONS**  
 PROJECT : ANDREW  
 LOCATION : USA

drawing title      date 18/10/2018      scale NTS

**STEP 8**



53x Jl.Uluwatu 2, Jimbaran-Bali-Indonesia  
 Phone/fax: +62 361 8472 101  
 info@pt-touchwood.com  
 www.pt-touchwood.com

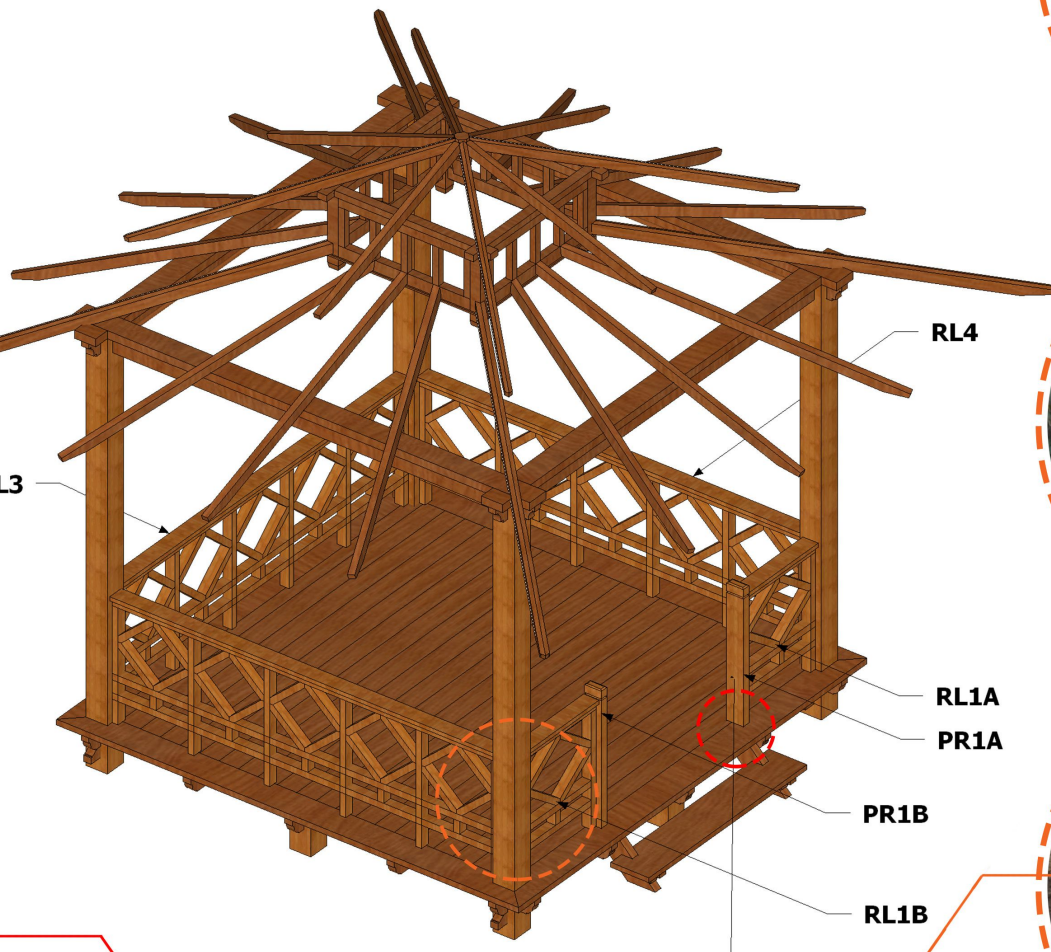

Post Railing 5 x 11 cm

- Railing to Post & Post Railing: DECK-SCREW 5 cm, 20 pcs
- Post Railing to Joist : Bolt 12 cm, 2 pcs

**ASSEMBLY INSTRUCTIONS**  
 PROJECT : ANDREW  
 LOCATION : USA

drawing title      date 18/10/2018      scale NTS  
**STEP 9**

53x Jl.Uluwatu 2, Jimbaran-Bali-Indonesia  
 Phone/fax: +62 361 8472 101  
 info@pt-touchwood.com  
 www.pt-touchwood.com

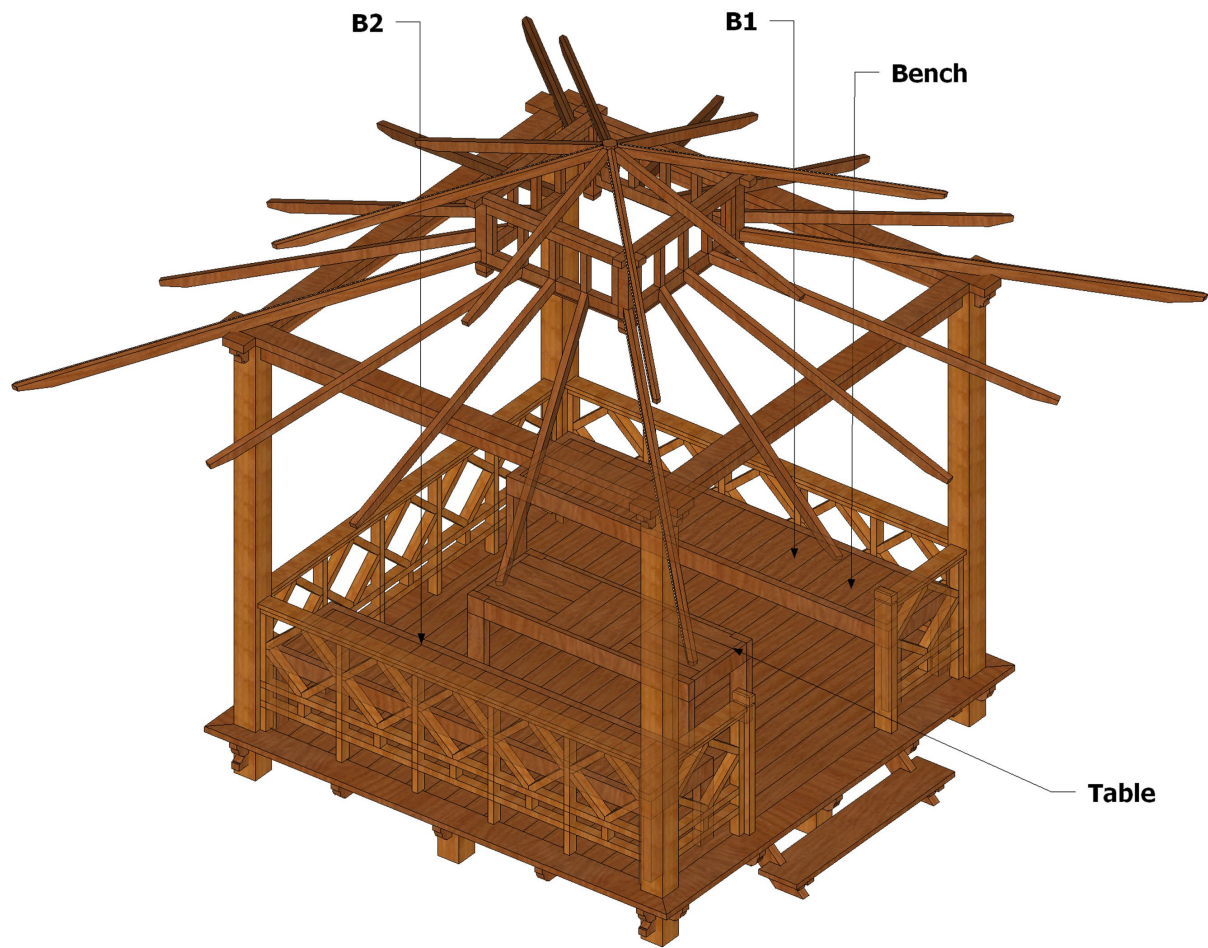

<b>ASSEMBLY INSTRUCTIONS</b>
PROJECT : ANDREW
LOCATION : USA

drawing title      date 18/10/2018      scale NTS

**STEP 10**



53x Jl.Uluwatu 2, Jimbaran-Bali-Indonesia  
Phone/fax: +62 361 8472 101  
info@pt-touchwood.com  
www.pt-touchwood.com

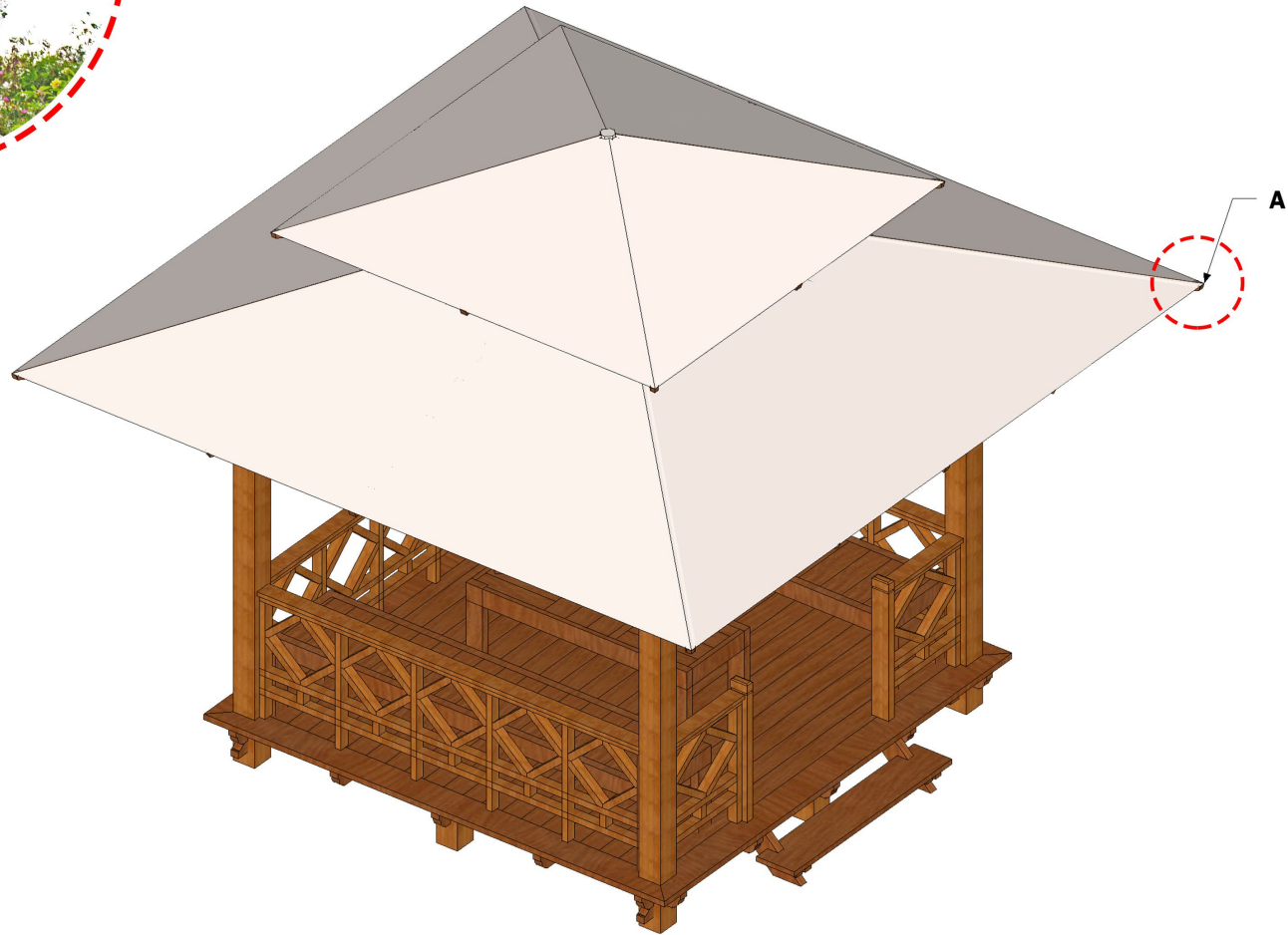

<b>ASSEMBLY INSTRUCTIONS</b>
PROJECT : ANDREW
LOCATION : USA

drawing title                      date 18/10/2018                      scale NTS

**STEP 11**



53x Jl.Uluwatu 2, Jimbaran-Bali-Indonesia  
Phone/fax: +62 361 8472 101  
info@pt-touchwood.com  
www.pt-touchwood.com